

LOUISIANA STATE UNIVERSITY

CAMPUS SITE & LANDSCAPE DESIGN GUIDELINES & STANDARDS

JULY 2019

LSU



TABLE OF CONTENTS

1.0 INTRODUCTION

1.1 Foreword	06
1.2 The Role of Campus Landscape	08
1.3 Master Plan Framework	10
1.4 Understanding Campus Character	12
1.5 Campus Design Guidelines	14
1.6 Landscape Design Objectives	18
1.7 Essential Elements of Landscape	19
1.8 How to Use this Document	20

2.0 PERFORMANCE GUIDELINES

2.1 Campus Landscape Typologies	
Building Entries	26
Promenades	28
Plazas	30
Courtyards	32
Quadrangles	34
Greens	36
Habitat	38
Corridors	40
Service Areas	42
Surface Parking	44
Thruways	46
Internal Roads	48

3.0 MATERIAL AND COMPONENT STANDARD CATALOG

3.1 Circulation	Streets	52
	Sidewalks and Crosswalks	52
	Curb & Curb Ramps	53
	Pathways	54
	Pavings	55
3.2 Furnishing	Benches & Tables	60
	Litter Receptacles	63
	Bike Racks	64
	Bollards	65
	Screening	66
	Art	67
	Wayfindings	67
3.3 Lighting	Pathway Poles	70
	Roadway Poles	71
	Illuminated Bollards	72
	Accent and Uplighting	73
	Embedded Lights	74
	Wall-Mounted and Ceiling Lights	75
3.4 Topography	Landform & Soils	78
	Ramps & Sloped Walks	79
	Stairs & Railings	80
	Site Walls	81
3.5 Water	Hydrology	82
	Drain & Storm Water Collection	83
	Irrigation	84
3.6 Canopy	Live Oak	86
	Canopy & Evergreen Trees	88
	Ornamental & Palm Trees	90
3.7 Garden	Shrubs	92
	Perennials	
	Ornamental Grasses	
	Groundcover	
3.8 Lawn	Lawns	96

1.0 INTRODUCTION

1.1 FOREWORD

1.2 THE ROLE OF CAMPUS LANDSCAPE

1.3 MASTER PLAN FRAMEWORK

1.4 UNDERSTANDING CAMPUS CHARACTER

1.5 CAMPUS DESIGN GUIDELINES

1.6 LANDSCAPE DESIGN OBJECTIVES

1.7 ESSENTIAL ELEMENTS OF LANDSCAPE

1.8 HOW TO USE THIS DOCUMENT



1.1 FOREWORD

Louisiana State University's flagship campus is most often recognized for its broad canopies of Live Oak trees, sweeping planes of lawn, verdant semi-tropical gardens, and iconic Italian Renaissance architectural style. These elements give form to a sprawling suburban campus set on the banks of the Mississippi River and provide the spaces where LSU's core mission of research, education, and outreach is able to thrive. Beginning with the first plan for LSU's campus, created by noted landscape architects the Olmsted Brothers in 1921, realized by Theodore Link later that decade, and updated by E.A. McIlhenny in the 1930s and 40s, the careful design and curation of the landscape of LSU has led the way for generations of growth while preserving its culture and agrarian heritage.

Continuing its history of planning leadership and excellence, in 2016 the University commissioned a Comprehensive and Strategic Campus Master plan to update previous plans and guide physical development of the campus over the next decade and beyond. In support of the master plan goals and principles, the University has created this document - the LSU Campus Landscape & Site Design Guidelines & Standards - to further guide implementation of the ongoing and future site developments envisioned by the master plan, as well as establish a set of standard practices for landscape infrastructure improvements that occur on campus every day.

Working with the university's team of landscape architects, architects, engineers, horticulturists, grounds crews, safety professionals, student life representatives, and various other campus stakeholders, the Design Guidelines & Standards have been crafted to address the character, performance, and construction of a range of exterior spaces commonly found across campus. These spaces, such as quads, plazas, drives, and pedestrian malls, and the elements that make them into the engaging and comfortable venues for learning and socializing, are described and defined in detail.

The standards set forth within this document have been vetted by years of testing, maintenance, and observation of the landscape. While these recommendations represent the best-practices for the campus at the time of its development, they have been created with flexibility in mind. As the campus continues to grow and evolve into the future, the framework set forth here should accommodate new techniques, design considerations, and technology to maintain the campus' high standards.

Intended as a guide for both the development of new campus places and the stewardship of existing landscapes, this document should be referenced by all designers who work on campus, as well as the trained staff who keep the campus clean and safe for the LSU community. As the primary landscape and site design tool for the campus, it is most useful when consulted early in a project, and when followed in conjunction with the Master Plan framework as well as the Campus Design Guidelines, a document that sets forth the underlying principles of campus planning and design at LSU. The resulting application of the design framework, principles, guidelines, and standards will ensure that the consistency, clarity, and beauty of the landscape is maintained for future generations of LSU Tigers.



The Campus Site & Landscape Design Guidelines & Standards is a component of the Overall Campus Standards under the Design Guidelines built in concert with the LSU Campus Master Plan. Depending on the scale and specifics of any given project, attention to each of these documents to a greater or lesser degree is required for all design teams.

COMPREHENSIVE & STRATEGIC CAMPUS MASTER PLAN

- BIG PICTURE PLANNING STRATEGIES
- GROWTH NEIGHBORHOODS
- CAMPUS DEVELOPMENT FRAMEWORK

DESIGN GUIDELINES

- CAMPUS DESIGN PRINCIPLES
- GOVERNANCE STRUCTURE

CAMPUS STANDARDS

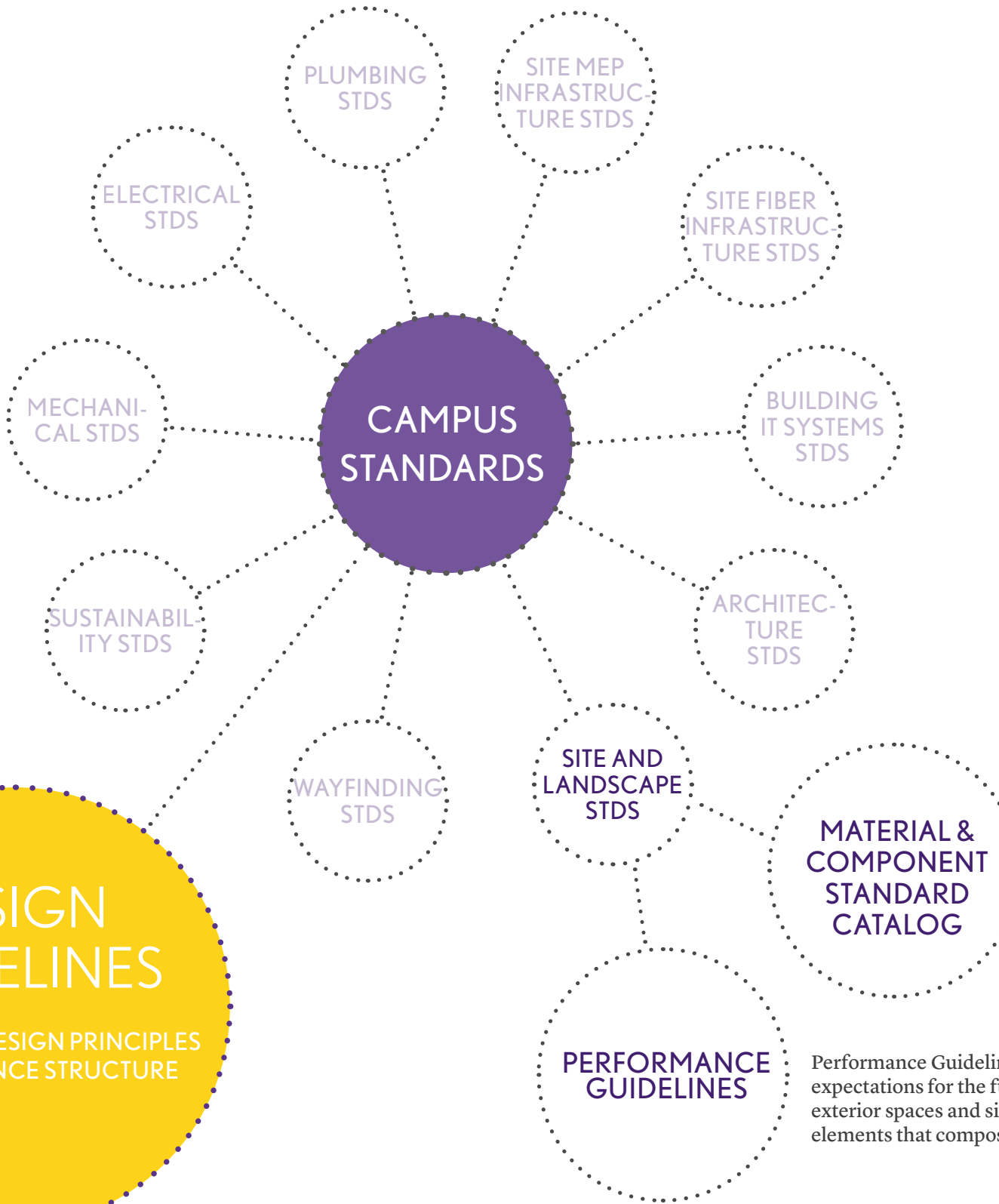

The Standards Catalog describes the types of materials and components that are to be employed on campus and best practices for their use.

Performance Guidelines define the expectations for the function of campus exterior spaces and site and landscape elements that compose them.

1.2 THE ROLE OF CAMPUS LANDSCAPE

LANDSCAPE HISTORY

The original campus plan was established in 1918 on a 650 acre plateau south of downtown Baton Rouge and designed by Fredrick Law Olmsted, Jr. of Olmsted Brothers in 1921. The plan, originally accounting for 3,000 students, established a cruciform-shaped quadrangle as the center of campus. Theodore Link, a New Orleans architect, designed the architecture of the core in the Italian Renaissance style.

During the 1930's, the campus received significant funding and expanded rapidly, draining the adjacent swampland and developing the University Lake system. Steele Burden, LSU Campus Gardener, began an extensive street tree planting of Southern Live Oaks and Southern Magnolias during the same period.

The live Oaks planted by Steele Burden in the 1930's and 40's have matured to create one of the most iconic campus landscapes in the United States. The Live Oaks have become an integral part of LSU's culture and identity and have been valued at over 50 million dollars. The current inventory of over 1000 Live Oaks are mapped and many have been endowed to provide funding for their care.

Originally very sunny and formal, the campus character has evolved into a campus deeply shaded by canopy, with a broad palette of medium to low height plants materials and expansive connected lawns. In addition to the Live Oaks and Southern Magnolias, LSU's campus includes traditional southern favorites, tropical and semi-tropical plants, and more contemporary ornamental grasses.

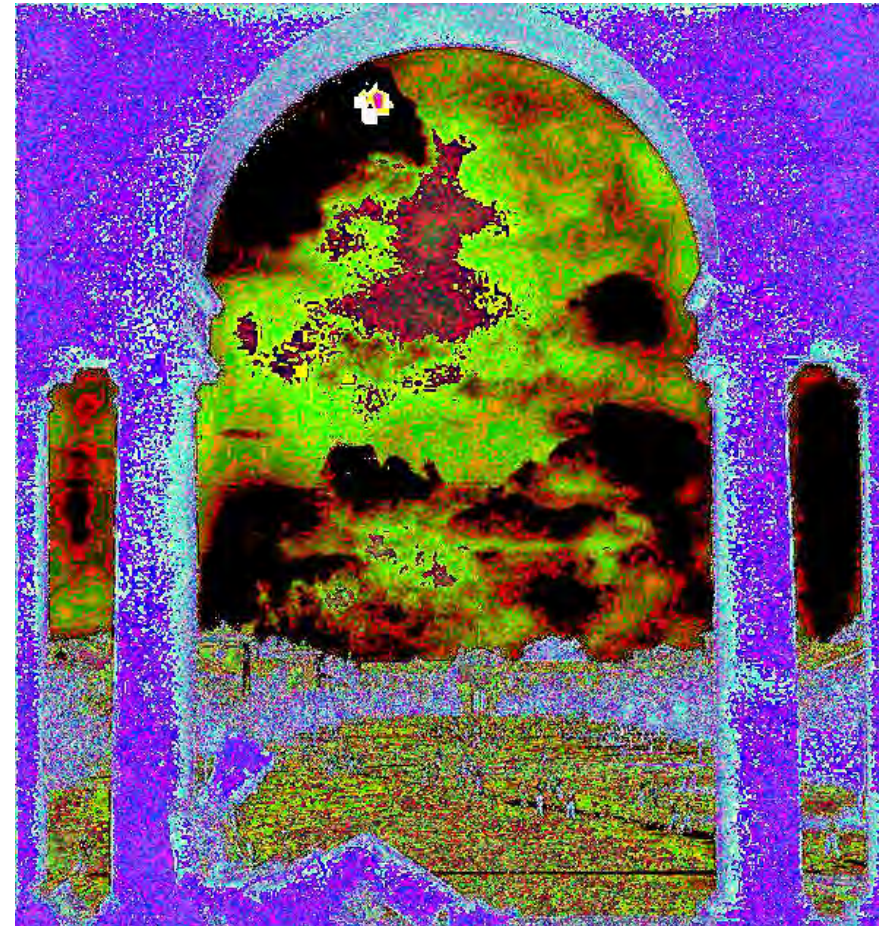

An open view across the quad from Atkinson Hall

CONTINUING A LANDSCAPE HERITAGE

As Louisiana State University's campus continues to grow, the need for consistency and standardization in design elements arises. These elements provide guidance, continuity, and communicate visual clues that form a framework, binding the outdoor spaces into a beautiful, coherent campus.

The campus standards developed over years of trial and error and are intended to serve the campus for the foreseeable future. Durability, maintenance and practicality have influenced the development of the current standards. In a number of cases, straightforward, classic design elements have been selected.

The campus landscape is also aspirational - serving as an educational tool and outdoor classroom for an array of academic programs. For more than 60 years, the landscape architecture program has developed an international reputation, using the rich cultural heritage and physical setting of southern Louisiana, the lower Mississippi Delta, and the LSU Campus as an invaluable resource for the study of landscape architecture.

Campus arrival begins as you pass the historic gates at Highland Road and Nicholson Drive. The experience is then enhanced with balanced landscape and architecture, utilizing site elements that support campus function and campus life. Just as the live oak trees, magnolia trees, and building arches are iconic of LSU, the lighting, wayfinding, and site furnishings will also indicate to a visitor that they have arrived at LSU.

ESTABLISHING COMPONENT FAMILIES

The goal of the LSU Campus Site Guidelines and Standards is to guide designers towards the fundamental elements that make LSU unique and beautiful. In an effort to establish a consistent language of furnishings, materials, and wayfinding related to various character zones on campus, the Guidelines and Standards should be used as a framework to make decisions. Rather than a prescriptive list of requirements or products, this document provides designers and campus staff flexibility in decision making, while meeting overall current and campus goals and design principles. All site elements will be reviewed by LSU Planning, Design, and Construction staff for adherence to this framework.

As a result of growth over time, distinct character zones have emerged and developed throughout the campus. Location, context, and use influence what is considered aesthetically and functionally appropriate in each zone or district. Principles and essential elements have been established to guide design and development of existing and proposed spaces on campus, further reinforcing the overall identity of the campus while defining distinct spaces moving forward.

Campus landscapes should be designed with some combination of the “Essential Elements” defined in this book, while also incorporating Design Guidelines principles of Linkages, Layering, and Social Spaces, to develop and shape campus spaces. Vegetation should thoughtfully define and frame flexible open space, mediate building scale, and provide shade, all with topographical context and maintenance requirements in mind. Material consistency and circulation hierarchy can establish a connective and clear network that respects distinct districts without compromising master plan framework systems. The role of water on campus should thoughtfully incorporate multiple stormwater management tactics at a range of scales.

Most important to maintaining a consistent campus character are the elements that bring function and animation to the campus. Site components including furnishings such as benches, tables, and lights, promote unity and socialization. Bus shelters, screening, paving, crosswalks, bollards, and striping further reinforce clear circulation and wayfinding. Abundant bike racks, the development of designated bike lanes, trash receptacles, and the installation of LED light fixtures provide tangible evidence of the University’s commitment to sustainability.



1.3 MASTER PLAN FRAMEWORK

The Comprehensive and Strategic Campus Master Plan adopted in 2017 creates a framework for the multitude of systems and structures that allow the campus to function cohesively. Many of these systems relate to open space, circulation, and the campus landscape environment. Designers and University staff working on built-environment projects within the campus should be familiar with the master plan and its framework to ensure their efforts are aligned with the fundamental goals and objectives of the plan.

The framework diagrams shown here are referenced from the master plan to illustrate the systems-level planning that drives campus growth and improvements. Review the master plan document for more information.

- QUADS
- MAJOR OPEN SPACES
- INTERSTITIAL OPEN SPACES
- PARKING LOT FOREST
- EXISTING CAMPUS BUILDING
- PROPOSED CAMPUS BUILDING
- MAJOR CIRCULATION ROUTES
- CAMPUS BOUNDARY

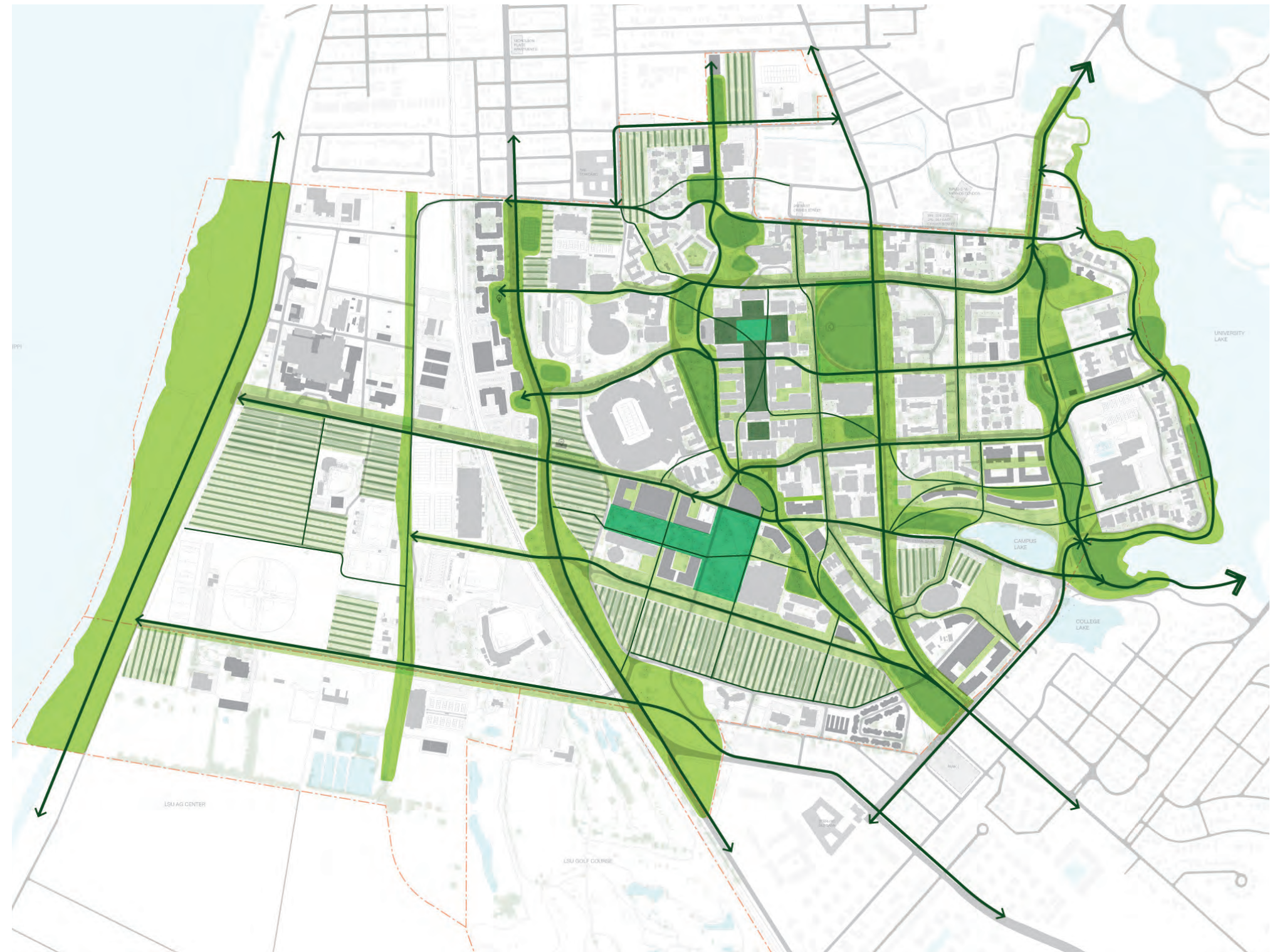



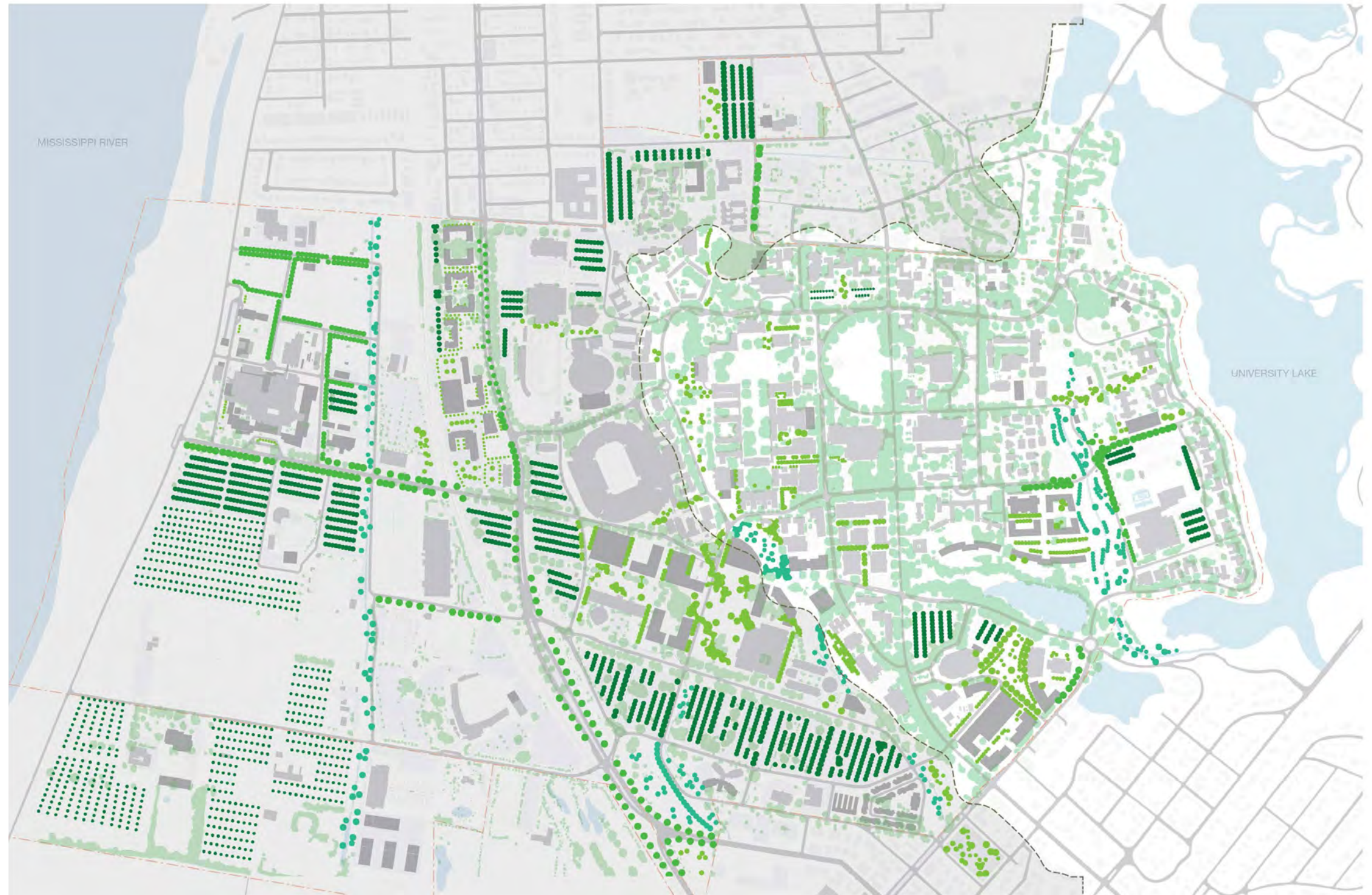



OPEN SPACE & PEDESTRIAN CIRCULATION NETWORK

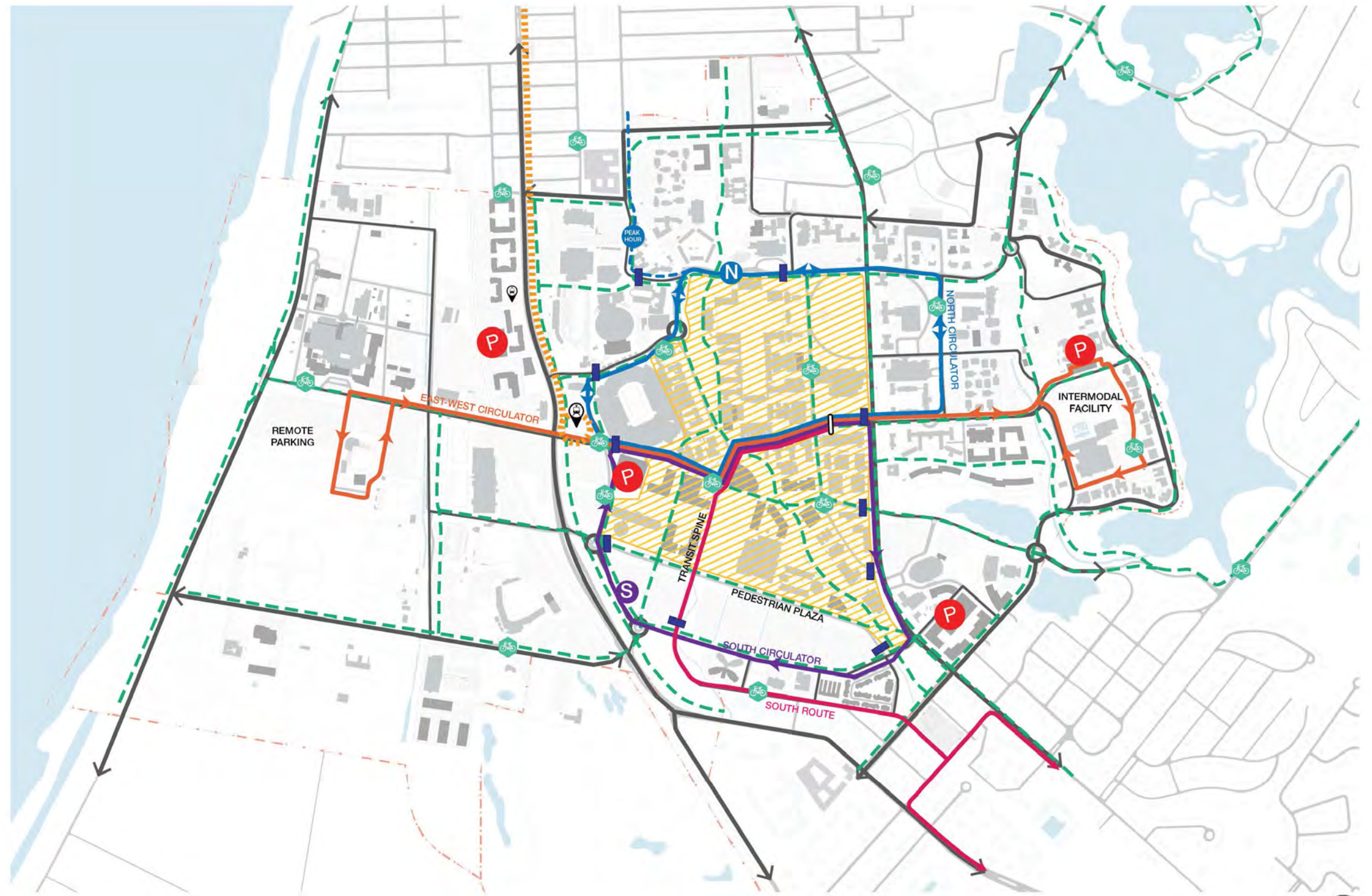

- PROPOSED STREET TREES
- PROPOSED PARKING LOT FOREST
- PROPOSED LOWLAND CANOPY
- PROPOSED CAMPUS CANOPY

TREE CANOPY



-  PEDESTRIAN CORE
-  CAMPUS GATE
-  VEHICULAR CIRCULATIONS
-  BIKE FACILITY
-  BR TRAM

VEHICULAR CIRCULATION



BICYCLE CIRCULATION

1.4 UNDERSTANDING CAMPUS CHARACTER

LSU's campus is composed of several eras of development and design style, resulting in an overlapping mix of site components and treatments. Landscape designs should take these variations into account and work within the families of materials, furnishings, and vegetation set forth in this document to create spaces that are reflective of the scale and character of the campus districts.

ACADEMIC - HISTORIC

- Historic core of campus
- generally defined by small scale academic buildings with modest material expression
- landscapes are more detailed because of narrowed spaces between buildings
- vegetation palette relies highly activated on garden planting below mature ornamental & canopy trees, primarily Live Oak, with minimal lawn
- hardscapes primarily defined by circulation paths and vehicular surfaces

ACADEMIC - CONTEMPORARY

- represents expansion of campus to the south defined by larger, more contemporary buildings
- landscapes are broad spaces or wide passages reflecting the scale and era of the development
- vast lawns are punctuated by groves of Live Oak and other lowland trees
- service roads are repurposed as campus drives and pedestrian corridors
- predominantly in the "lowland" zone of campus, indicated by the presence of channelized bayous and occasional flooding.

RESIDENTIAL & STUDENT LIFE

- areas include the primary dorm and apartment developments as well as recreation and 'mixed use' zones of campus
- currently a mix of historic, mid-century, and contemporary architecture.
- master plan includes rapid redevelopment of these areas, creating new opportunities for landscape improvement
- landscape spaces of mixed scale including courtyards, parking lots, and some recreation spaces
- programmed outdoor spaces and well designed circulation for campus connectivity

ATHLETICS

- defined by large sports facilities and playing fields
- landscape spaces experience a heavy demand for pedestrian circulation and vehicular support
- large non-sport field spaces are predominantly parking surfaces with some plaza and tree canopy
- fencing for controlling events restrict campus circulation. Also athletics venue parking and plazas near the campus core share use with academic campus circulation

AGRICULTURE

- defined by low, wide support buildings and School of Veterinary Medicine
- large expanses of grass and fields, primarily for grazing and some converted to temporary parking
- tree cover limited to sidewalks and roadways with minimal intermittent shade
- wet soils susceptible to flooding

PEDESTRIAN SPINES

- represent continuous pedestrian corridors with consistent character and branding
- serve as a link between distinct spaces within and between precincts
- creates opportunities for a unique expression of circulation systems that unify the campus



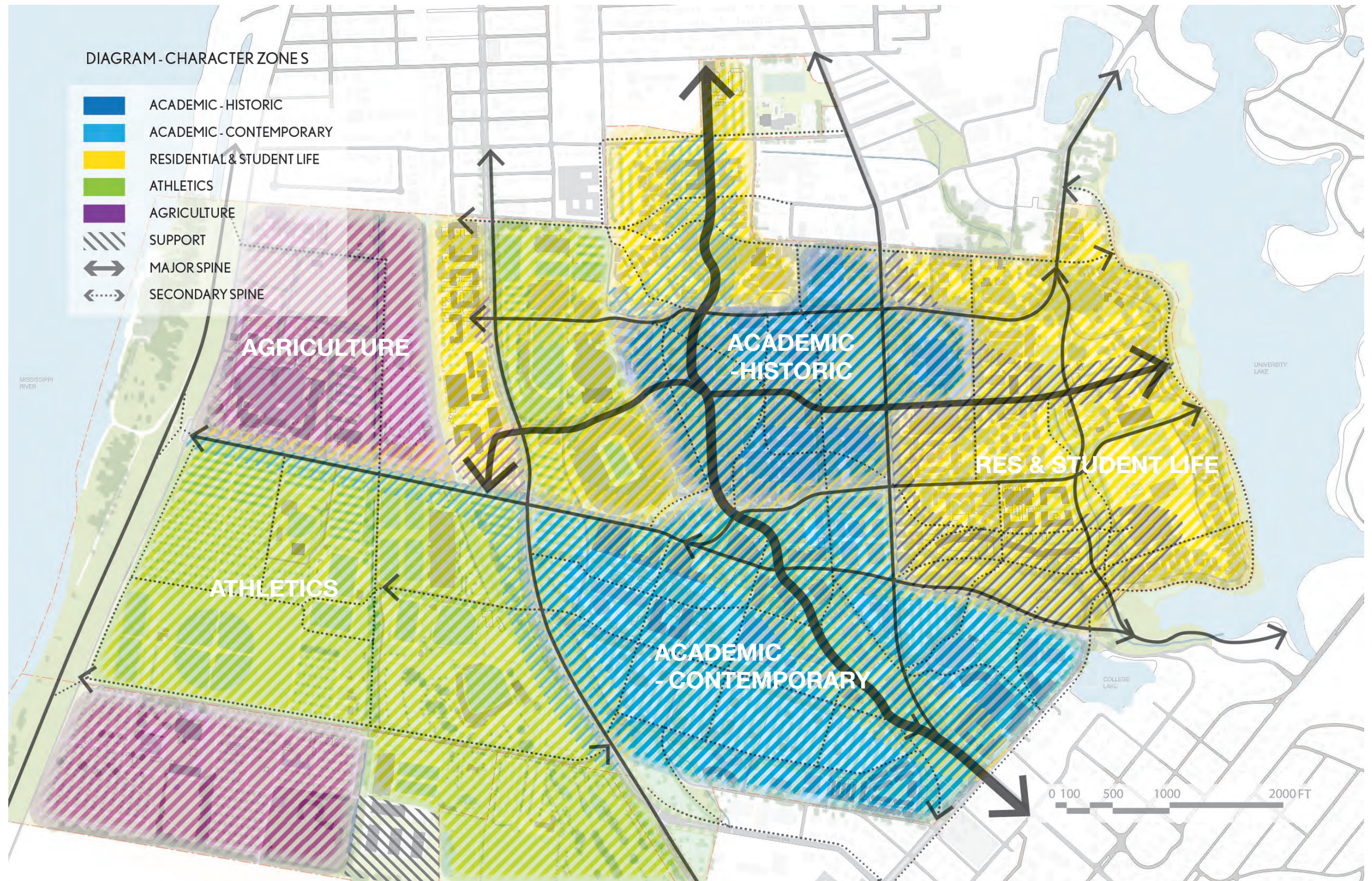

1.5 CAMPUS DESIGN GUIDELINES

The Campus Design Guidelines establish a set of design principles that apply to both architectural and landscape design on campus. These principles should guide an integrated design and planning approach, and are referenced here. See the Campus Design Guidelines for more information.

PRINCIPLE 1: TIME AND PLACE

Create building sensitive to both time and place. Designers should respect the historic context of the campus while also addressing both the challenges and opportunities of contemporary learning environments. New buildings should be neither faux historic replications nor pure expressions of modernity, but unique contributions to context, knitted together by timeless Louisiana landscapes.

The campus landscape should reflect its design heritage as well as the intrinsic character of the local ecology, taking into consideration the topography, hydrology, soil, and exposure of each site. Successful campus landscapes rely on components of open lawn, canopy, and paths to establish a walkable, human-scale that knits the campus together.



PRINCIPLE 2: LINKAGES

Human-scale connections that respond to the heavy rainfall and intense sun of the deep South are fundamental to LSU's success as a walking campus. Linkages that are most effective provide clear wayfinding and direction to campus destinations, mediate architectural changes between buildings, protect openings and entrances, and create engaging experiences. Linkages must allow people of all physical abilities and familiarities with the campus to move comfortably and safely; providing seating, lighting, and universal accessibility. Arcades have historically provided linkages between buildings at LSU and, when used in new projects, their design should adapt to contemporary design goals and programmatic challenges while maintaining their historic function. Landscape is an integral part of a linkage, both historic and new, with the benefit of expanding past a project boundary to knit together the campus environment.



Successful linkages provide safe, comfortable, human-scale pathways connected to the landscape and campus circulation network.

PRINCIPLE 3: LAYERING

Layering should be a design consideration around buildings as well as between them. Program pathways with a succession of spatial scales, such as smaller courtyards and corridors that open into larger areas, to create a campus environment that rewards walking. Use layering to reduce the mass of large buildings, establish human scale at the ground level, and provide prospect and engaging views at upper levels. Design layers in such a way that pedestrians perceive landscape and building as an integrated spatial environment - one that is inviting, lively, and connected.



Use layering to provide an incremental transition between building and landscape, establish human scale, and create an environment that rewards time spent outdoors.





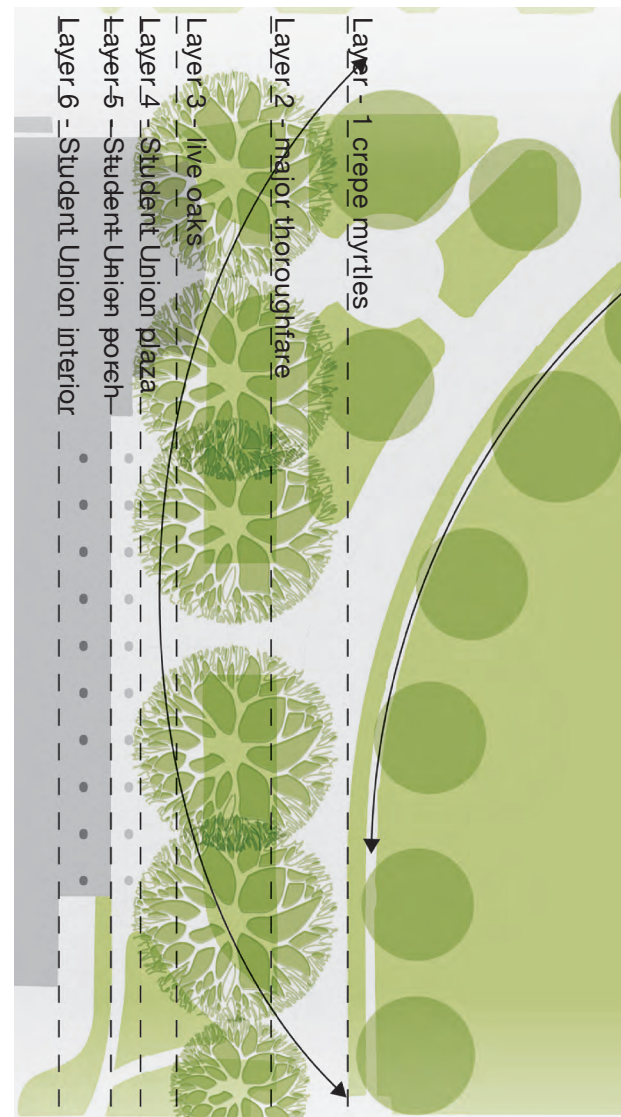

The south stair reaches into the landscape



Pedestrians encounter the north side of the student union through several layers of landscape and building elements

PRINCIPLE 4: SOCIAL SPACES

LSU is a campus where academic life happens in public, and the opportunity to share information in social spaces benefits learning, emotional well-being, and campus culture. Successful social spaces are programmatically flexible, comfortable, safe, represent varying scales, and allow for quiet and active inhabitation. New construction should create well-defined social spaces with the opportunity to spill from indoors to out, convenient to major pedestrian and transportation thoroughfares, and which accommodate activities essential to campus life. Design the ground floor of buildings and surrounding landscape to welcome movement between the two. Exterior communal spaces that serve adjacent buildings should reinforce information exchange and campus vitality.

SCALE	S	M	L	XL
PROGRAM	quiet study intimate break-up space naps	group study class presentations performance	people-watching communication events	exhibitions ceremonies sports
EDGE	BUFFERED / PRIVATE	PERMEABLE BUT REMOVED FROM ACTIVITY	CONNECTED / THOROUGHFARE	OPEN / FLEXIBLE
EXAMPLES				

A healthy campus has diverse social spaces that vary in program, scale, and edge condition. Designers should analyze their project's surroundings to determine what type of social space their project would best contribute to the campus.

PRINCIPLE 5: HUMAN SCALE

Human scale is not exclusively about the dimensions of the human body but also touch, sound, and visual perception of distance. Use transparent glass and light penetration within building interiors to extend visual perception past the barrier of the facade. Design textures, articulation, and mass that can be appreciated at the scale and speed of a pedestrian. New parking garages are envisioned by the 2017 Master Plan and these vehicular structures contribute most to campus when wrapped with pedestrian-oriented uses at the ground floor. Amenities such as small retail areas, bike cages, and coffee shops provide activity, safety and human scale around garages and other large structures.

Campus landscapes

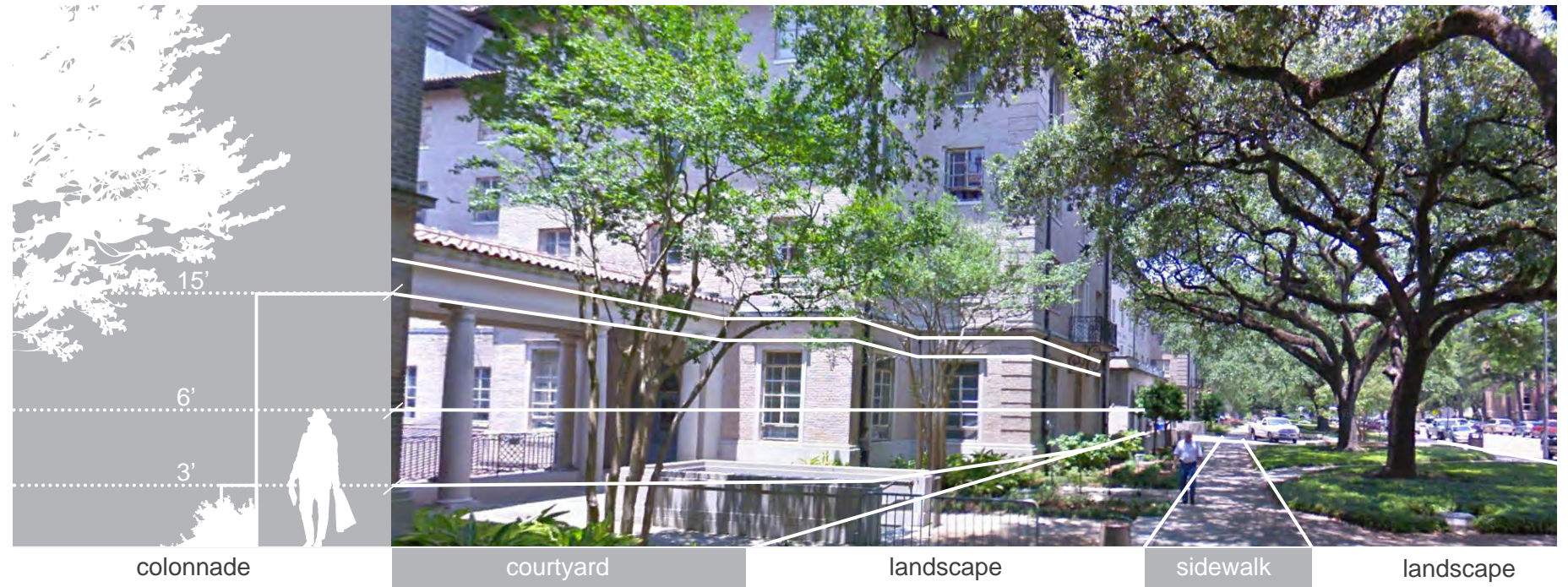

The Hatcher, Johnston, and Hodges Halls provide human scale proportions at the ground floor, ample openings, and fine grain articulation. Landscape layers break up the large building frontage, buffer road noise, and mediate hot sun. The architecture bleeds into the landscape, and vice versa, blurring the lines between one and the other. It is important to note that the design quality of this place has almost nothing to do with whether the building is an original historic structure or a more contemporary addition to the campus; the intrinsic qualities of good design are indeed timeless.

PRINCIPLE 6: DESIGN ELEMENTS

Landscape design can serve as the “connective tissue” across the campus, not only enhancing the linkages and layering of campus buildings, but also creating aesthetic continuity between buildings of varied scale, character and typology. Vegetation together with material consistency and circulation hierarchy can establish a connective and clear network that respects distinct districts without compromising Master Plan framework systems. Open spaces serve as places for gathering and program, and further the spatial continuity of the campus landscape.



Canopy effectively frames views in this historic core, and provides much-needed shade.



Shade and adequate paths reinforce movement through the campus.



Unique cultural and historic landscapes, such as the dramatic topography of the ancient archaeological burial mounds, are woven into the campus fabric.



Plant selection relates to topographic and soil conditions in low, wet areas of campus, and can serve as a filter for stormwater as well as providing erosion control.

PRINCIPLE 7: SUSTAINABILITY

LSU is committed to producing not only high-performing academic and athletic institutions, but environmentally sustainable ones as well. Valuing environmental performance positions LSU as resilient, cost-efficient, rooted in its context and, most importantly, invests in LSU's most important resource—its people.

Health and safety are key components of a high-performing campus and landscape should optimize visual, acoustic comfort as well as traffic movements.

New projects should incorporate best management practices for permeable surfaces, stormwater collection and storage, and self-sufficient, climate-appropriate plantings to meet the challenge of Louisiana's extreme weather events. Celebrate stormwater with visible and attractive components of a macro and micro-scale stormwater management system, such as providing supplemental irrigation in courtyards, and allowing lawn spaces to temporarily detain water during heavy rains and floods.

Sustainability is also measured by the amount of input and maintenance that landscapes require. By carefully designing and placing landscape elements, the economic and environmental burdens of landscape maintenance can be reduced. A beautiful, well maintained, and safe campus helps to support itself by attracting and retaining students, furthering the mission of the university.

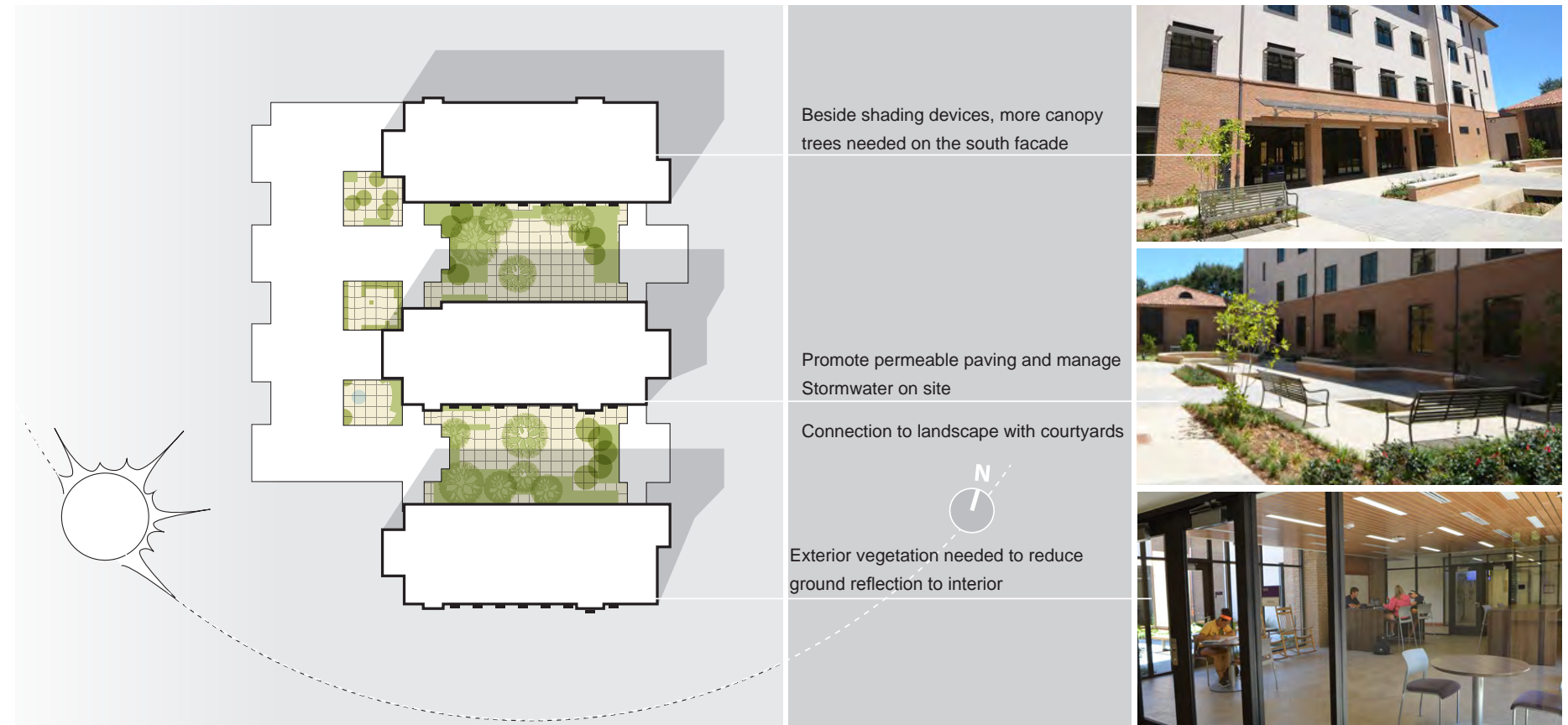

Example: Recent built Cypress Hall uses shading devices on the south side, self-shades on the north side, and is oriented east-west for maximum solar control. Its massing is split into three towers and incorporates five courtyards to provide well-daylit interiors and connection to the landscape. More landscape elements could be integrated into the exterior to enhance the sustainable uses.

1.6 CAMPUS SITE & LANDSCAPE DESIGN OBJECTIVES

The following design objectives describe the goals and expectations for site and landscape improvement projects on campus. These objectives should guide decision-making throughout the design and implementation process for projects of all scales, budgets, and importance. The objectives provide the supporting rationale for the following sections of this document, Performance Guidelines and Standards Catalog.

- Assert a campus site **character** that coherently reflects and reinforces the **identity** of LSU
- Prioritize the **pedestrian experience** and provide a **clear hierarchy** of campus systems
- Landscape design should purposefully **enhance architecture** and shape the campus into **meaningful, useful, and memorable places**
- Develop material and furnishing **families** that bring **consistency** and are **adaptable** to change
- Select materials and furnishings that are **durable, maintainable, sustainable, and replaceable**
- Locate furnishings so they are **functional and usable** by the entire campus community
- Preserve and enhance the **ecological and horticultural vibrancy** of the southeast Louisiana landscape
- Accommodate the unique challenges that **gameday and major events** present for the campus
- Promote campus **safety** and wayfinding through balanced lighting and circulation systems
- Reduce fixture **glare** and correct **color quality** to improve the campus nighttime experience
- Promote both lighting **performance and aesthetic** quality

1.7 ESSENTIAL ELEMENTS OF LANDSCAPE

All campus landscapes are informed by the eight basic elements described below. The Campus Site & Landscape Design Guidelines & Standards document uses these “Essential Elements” to convey the expectations for how campus landscapes are designed, and to organize categories of the individual components that define the spaces, surfaces, and features of the campus. Icons for each element typology provide a visual guide throughout the document.



CIRCULATION

Paths and roads, whether they are pedestrian, vehicular, bike, or some combination, should provide comfortable, safe and efficient routes for people to move through campus. This can be accomplished by incorporating a clear hierarchy of width and materiality that link spaces and relate to building entrances. Consistency in materials tie together disparate spaces that may vary in size, character, or program.

CATALOG SECTION

STREETS & SIDEWALKS
CROSSWALKS & CURB RAMPS
PAVING



FURNISHINGS

Seating, signage, and bike parking should be **clear and efficient but recede** within the campus landscape. When appropriately located along circulation routes or outside primary building entrances, furnishings reinforce **circulation**, activate **gathering spaces**, and provide **safety, comfort** and **security** to LSU students and visitors.

BENCHES & TABLES
LITTER RECEPTACLES
BIKE RACKS
BOLLARDS
SCREENING & FENCES
ART & WAYFINDING



LIGHTING

Light allows us to see the environment we interact with, can highlight essential parts of landscape and provide perception of safety in landscapes during night hours. The selection of light sources, distributions, beams spreads, mounting heights, spacing, and the desired light levels are important to provide good quality lighting. It is equally important to mitigate glare issues caused by light sources to ensure visual comfort. Fixtures also are visually noticeable objects of landscapes during daylight hours, which makes their aesthetics important to be carefully selected.

PEDESTRIAN POLES
ROADWAY & PARKING POLES
ILLUMINATED BOLLARDS
ACCENT & UPLIGHTING
EMBEDDED LIGHTS
WALL MOUNTED LIGHTS
CEILING LIGHTS



WATER

From the Mississippi River to Corporation Canal and the campus lakes, water has a major presence on the LSU campus. Future development, especially in the lowland, necessitates a purposeful and thoughtful engagement of **stormwater management practices** to not only collect and move water during and after storm events, but to transform the capture and treatment of stormwater into an **amenity** for the campus. To be effective, this process needs to take place at a range of scales - from developing a series of small swales along campus roads that slow water before entering larger detention areas for storage, to the **restoration** of canals to allow for drainage and a more productive local ecology.

CAMPUS HYDROLOGY
STORM WATER COLLECTION
IRRIGATION



TOPOGRAPHY

The **Highland Ridge** played a major role in the siting and structure of the historic core, serving as the primary organizing arrangement. Future building and landscape projects should carefully consider this natural change in topography. The designation between “**highland**” and “**lowland**” has implications on soil type, plant palette, and stormwater management techniques.

CATALOG SECTION

LANDFORM & SOIL
RAMPS & SLOPED WALKS
STEPS & RAILINGS
SITE WALLS



CANOPY

The ubiquitous, mature Live Oak canopy is one of the most significant features of LSU’s campus. Aside from providing much-needed **shade** between buildings, the canopy gracefully reaches to the ground, **framing and defining** important open spaces, and providing a backdrop to much of the activity on campus. With the careful introduction of a diverse and **native** palette of canopy trees, LSU has the opportunity to expand this extensive network, reinforce movement with shaded walks and highlight new campus spaces and hubs of activity. As the campus redevelops in key areas and grows to the south, canopy should be used to mediate the scale of larger buildings and reshape open space, making new areas of campus comfortable for pedestrians.

LIVE OAKS
CANOPY & EVERGREEN TREES
ORNAMENTAL & PALM TREES



GARDEN

Gardens on campus are expressive of a vibrant plant palette, consisting of a combination of native and adapted plants. While gardens can be an effective way to further break down scale, creating more intimate gathering spaces throughout the campus, they should be implemented with restraint as they require special care and additional maintenance. When used carefully, such as under large Live Oak canopy where other plants may not be viable, gardens can be a successful design element.

SHRUBS
PERENNIALS
ORNAMENTAL GRASSES
GROUND COVER



LAWN

Serving as a unifying feature, lawn is an essential component of the campus fabric upon which new development is sited. It provides both an inherent **durability** and **flexibility** in order to support many user groups and a range of activity - from tailgating to frisbee to study groups.

LAWNS
MEADOWS

1.8 HOW TO USE THIS DOCUMENT

1. REVIEW MASTER PLAN FRAMEWORK & DESIGN PRINCIPLES

Landscape projects on campus are part of a larger system of character, circulation, open space, and vegetation, and cannot be isolated from these systems. Understanding the big picture helps to inform the discreet design effort.

2. IDENTIFY TYPOLOGIES IN A PROJECT

A review of the master plan framework as well as the project brief will identify the program and components for a project. The site around any major project on campus can be organized into several spatial typologies, and those spaces will be designed to meet the university's landscape performance goals. Smaller projects may find more specific guidance in the catalog section of document.

3. REFERENCE THE STANDARDS CATALOG

This portion of the document defines materials, furnishings, and vegetation appropriate for use on the campus. It also outlines best practices and required metrics for systems of lighting, irrigation, roadways, and pathways that should be incorporated into all landscape designs.

The intent of creating a governance structure for Capital Project Execution is to provide a process to ensure that capital projects are executed in alignment with the Master Plan framework and intent (as part of the "approved planning documents" per LSU Statement PS 23.10.) The Design Guidelines document explains in further detail the intent of the various planning documents and the process by which campus projects are contracted, reviewed, and approved.

These approved planning documents, as seen in the figure to the right, provide varying levels of aspirational and prescriptive guidelines. The Master Plan provides the highest level aspirations for campus growth over the centuries and the Design Guidelines provide high level descriptions for how design can achieve those goals. The Site and Landscape Standards (refer to Appendix) and Facility Design Standards and Specifications documents provide more prescriptive requirements for architecture, landscape architecture, and engineering standards. For example, the Design Guidelines might encourage designers to create a building first floor which is public and showcases the activity within in order to create a vibrant campus, while, the Facility Design Standards & Specifications might specifically require use of transparent glass on the building facade.

The draft of Policy Statement 23.10 (PS 23) lays out the process for project approvals, including required submittals at each phase.

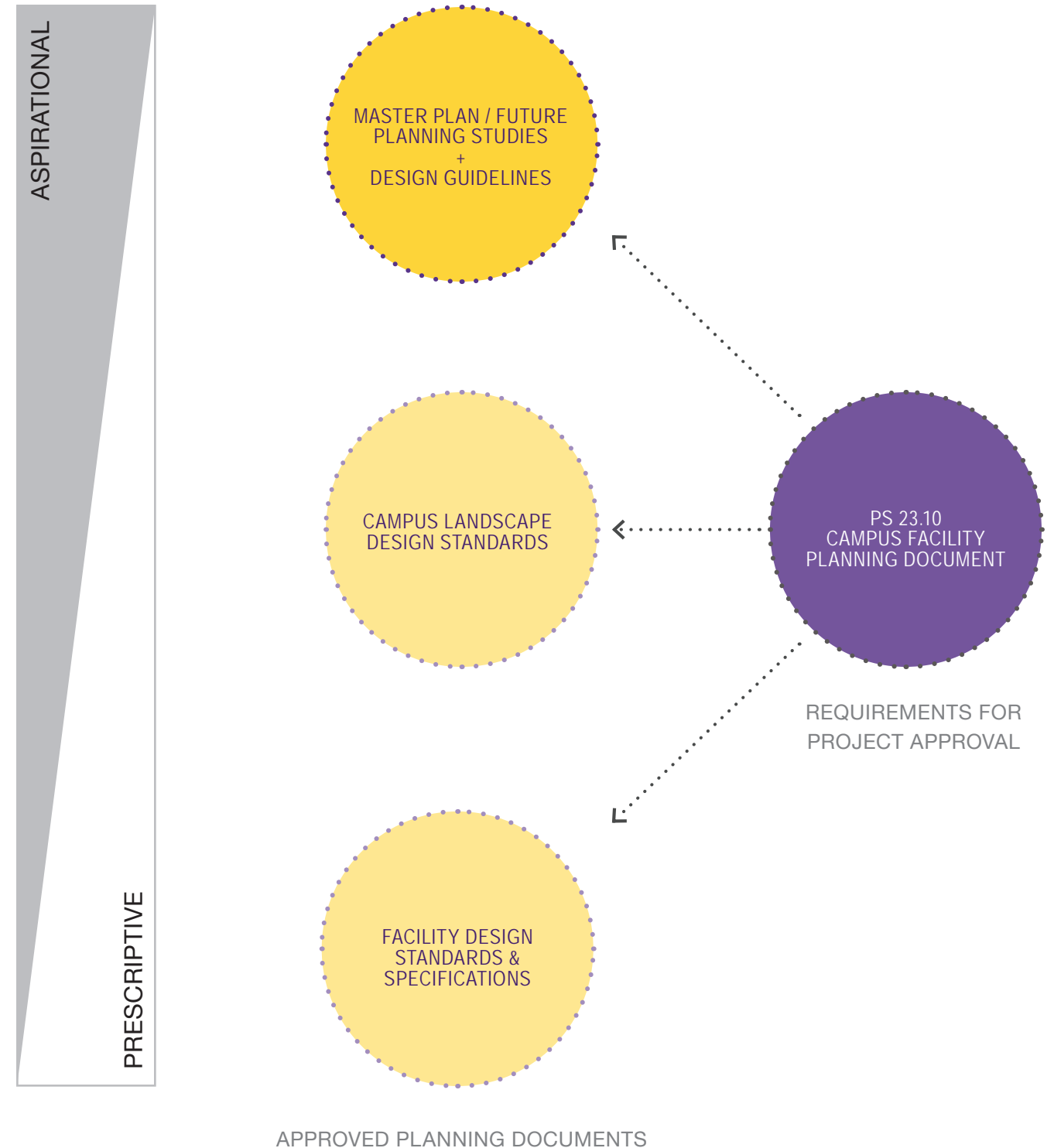

2.0 PERFORMANCE GUIDELINES











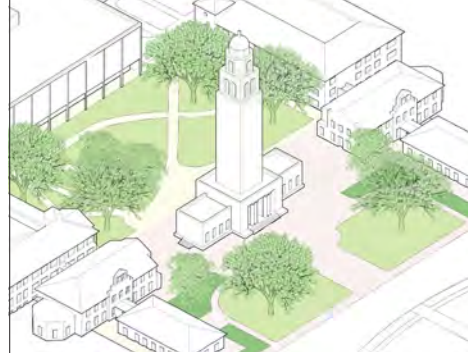

2.1 EXISTING CAMPUS LANDSCAPE TYPOLOGIES

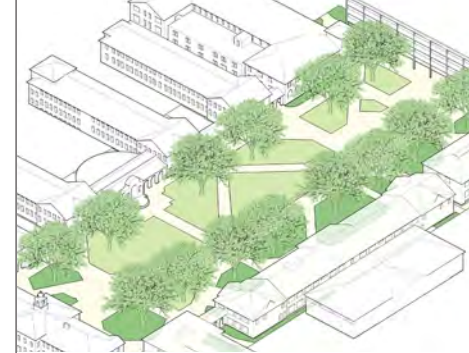









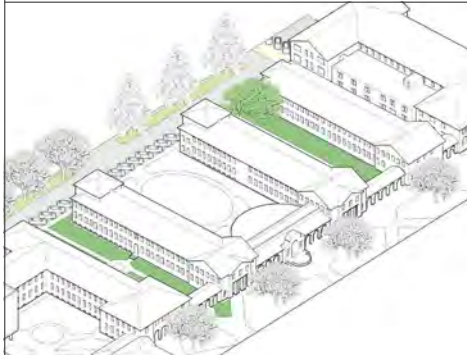

2.2 CAMPUS LANDSCAPE TYPOLOGY GUIDELINES

- BUILDING ENTRIES
- PROMENADES
- PLAZAS
- COURTYARDS
- QUADRANGLES
- GREENS
- CORRIDORS
- HABITAT
- SERVICE AREAS
- SURFACE PARKING
- THRUWAYS
- INTERNAL ROADS

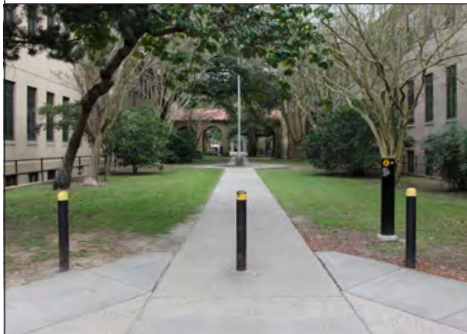
2.1 EXISTING CAMPUS LANDSCAPE TYPOLOGIES

LSU's campus is composed of several eras of development and design style resulting in an overlapping mix of site components and treatments. Landscape designs should take these variations into account and work within the families of materials, furnishings, and vegetation set forth in this document to create spaces that are reflective of the scale and character of the campus precinct.

BUILDING ENTRY	PROMENADES	PLAZA	COURTYARD	QUADRANGLE	GREEN
<ul style="list-style-type: none"> • Provide places for gathering and repose • Scale to accommodate classroom turnover and pedestrian flows • Provide fixed or movable seating, site amenities and way finding 	<ul style="list-style-type: none"> • Iconic traffic spine for pedestrian and bicycle • Extent of paving to accommodate emergency access • ADA applicable throughout • Flexible arrangement of space for special events 	<ul style="list-style-type: none"> • Extensive paved area with enhanced planting, building or major circulation on the edges • Provide flexibility for different events • Provide movable and fixed seating 	<ul style="list-style-type: none"> • Provide intimate spaces with seating for gathering, classroom and special events • Typically enclosed by buildings • Promote the uses of both shade and ornamental trees 	<ul style="list-style-type: none"> • Iconic space typically associates with major buildings • Ceremonial space to enhance the sense of community • Internal paths connect major buildings and direct pedestrian routes through and/or around 	<ul style="list-style-type: none"> • Large open areas of predominantly lawn • Flexible uses in special events • Provide shade • Typically adjacent to major circulation with easy accesses
<p>EXAMPLES</p>					
					
<p>Hodges Hall</p>	<p>Free Speech Alley</p>	<p>Memorial Tower Plaza</p>	<p>Laville Courtyard</p>	<p>Main Quad</p>	<p>Parade Ground</p>
					
<p>Foster Hall</p>	<p>Free Speech Alley</p>	<p>Book Store Plaza</p>	<p>Business Education Complex</p>	<p>Art Quad</p>	<p>Memorial Oak Grove</p>

CORRIDORS	HABITAT	SERVICE AREAS	SURFACE PARKING	CAMPUS DRIVES	THRUWAYS
<ul style="list-style-type: none"> • Interstitial space that connects major circulation routes • Typically provide seating, bike racks and other amenities, to serve adjacent buildings and landscape areas 	<ul style="list-style-type: none"> • Distinct eco-system that connects to a large scale wildlife area • Often adjacent to streams and stormwater conveyances through campus • Typically located in a natural setting with low development interference 	<ul style="list-style-type: none"> • Typically adjacent to buildings and away from major pedestrian circulation • Include areas for loading, parking and different service facilities 	<ul style="list-style-type: none"> • Close to major campus and city traffic connections • Provide open parking lots in different scales 	<ul style="list-style-type: none"> • Mainly for campus vehicular connections and service • Occasionally traffic controls for campus events 	<ul style="list-style-type: none"> • Major urban connectors • Typically for vehicular travel through campus • Very few traffic controls • Street trees on both sides
					
<p>West Quad</p>	<p>Corporation Canal</p>	<p>Nicholson/Coates Hall</p>	<p>Peabody Lot</p>	<p>Field House Drive</p>	<p>Highland Road</p>
					
<p>West Quad</p>	<p>Corporation Canal</p>	<p>Design Building dropoff</p>	<p>South Lot X</p>	<p>Tower Drive</p>	<p>Nicholson Drive</p>

2.2 CAMPUS LANDSCAPE TYPOLOGY GUIDELINES

BUILDING ENTRIES

Building entries are the spaces that connect campus site circulation to building circulation systems. They serve as primary gathering and interactions spaces for the campus community. The design of building entry landscapes should clearly indicate that one has arrived at an important moment on campus, and should be accessible for all.



CANOPY

- Use existing canopy where possible to create shaded circulation and furnishing areas
- Provide canopy where necessary to scale buildings and create filtered experiences



WATER

- Utilize trench drain at edges of paving to simplify grading and to move water off paving quickly
- Incorporate permeable surfaces where feasible based on soil and drainage characteristics
- Provide dedicated irrigation for gardens and lawns where possible; provide temporary irrigation at new trees



LIGHTING

- Provide appropriate light levels at plazas, paths, steps, ramps, bike parking and building entries
- Avoid high contrast between lighting levels of building vestibule, plaza areas and campus circulation routes
- Use sconces, facade lighting or other lighting elements at main entries or other high profile elements to help wayfinding



GARDEN

- Use garden to highlight building entry and control cross-circulation
- Consider consistent masses of groundcover at building base and space below tree canopy, see Catalog for more preferred spacing and configurations

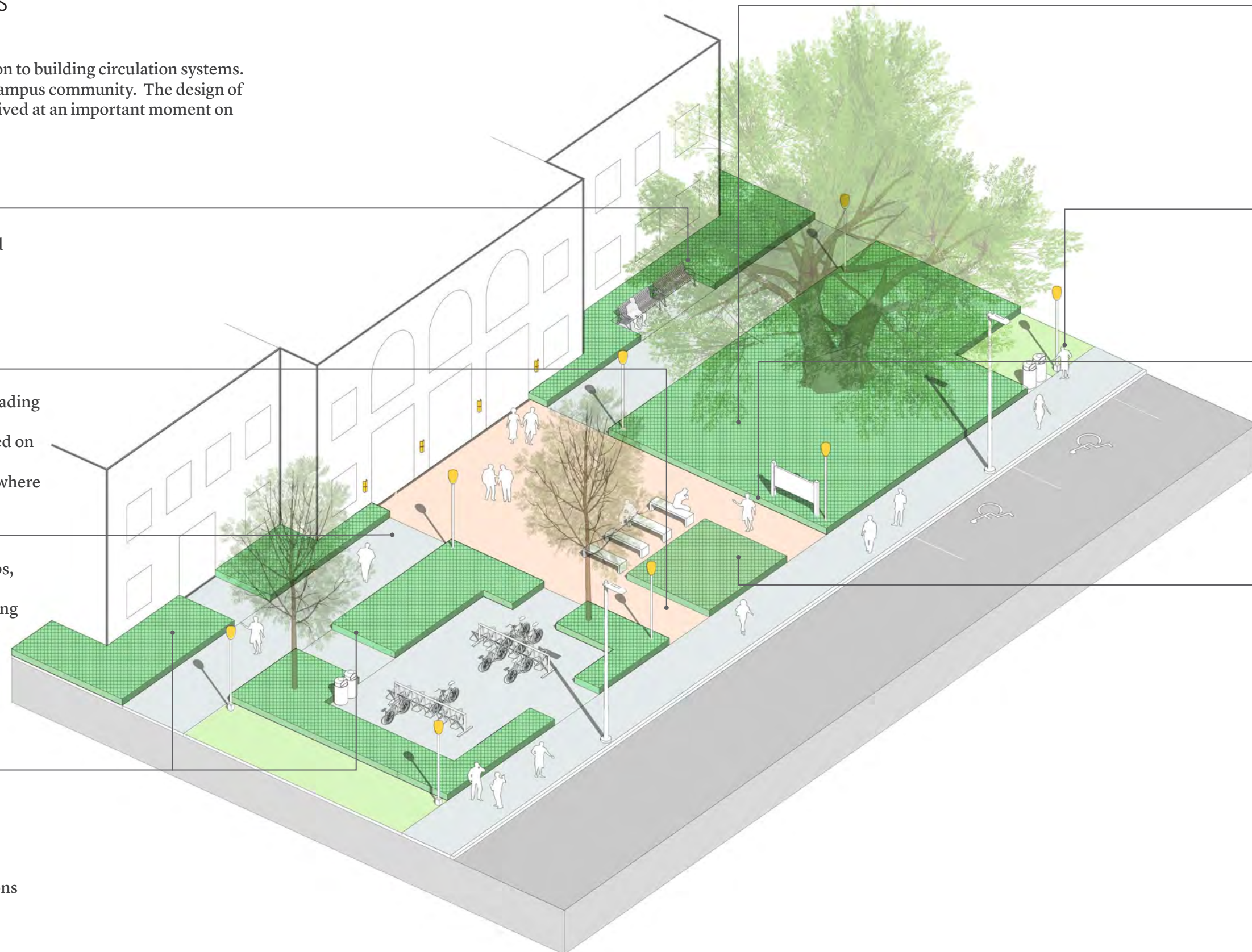



FURNISHINGS

- Place furnishings aside of main entry circulation
- Provide seating, receptacles, bike parking and other amenities in quantities proportional to current or anticipated programs' demand. Utilize standard modules, see Catalog
- Prioritize seating to shaded areas if possible
- Ensure signage is visible from major circulation route but does not have impact on amenity space
- Locate additional trash receptacle within the building where needed near building entrances and not on the site



LAWN

- Shape lawns to fill spaces and further highlight figures of garden and entry paving where buildings are set back from major circulation routes
- Use reinforced lawn in areas that anticipate high levels of use or game-day parking
- Avoid using lawn in areas densely shaded by live oaks



CIRCULATION

- Provide ADA parking spaces near entries where required, but don't conflict with major circulation patterns
- Paving material at entry plaza should provide an indication of an important transition, see Catalog for paving types
- Align secondary paths to direct movement to entry paving
- Provide enough width for movement to and from doors as well as informal gathering
- Extend surface materials and patterns to meet adjacent major circulation path



TOPOGRAPHY

- Provide ADA compliant transitions at doors and avoid the use of ramps and stairs to simplify accessibility when possible
- Pitch entry paving to create consistent planar surfaces
- Maintain slopes not to exceed 2% (1:50) in all directions

MAJOREVENT CONSIDERATIONS

- Vehicle parking on entry plazas and adjacent planting should be avoided



- X Lack of vegetation covering
- X Lack of site furnitures—benches, lighting, trash receptacles
- X No entrance space for gathering



- ✓ Planting in layers and appropriately scaled light fixture highlight the entry
- ✓ Special paving at the appropriate scale define the entrance space
- ✓ Site furniture and gathering space available without creating circulation conflicts
- X Stairs at entry necessitate unsightly ramps and handrails

2.2 CAMPUS LANDSCAPE TYPOLOGY GUIDELINES

PROMENADES

Pedestrian promenades serve as the primary circulation spines through campus. They connect major landscape spaces and typologies, but also act as gathering spaces. Their character remains consistent throughout. Promenades must respond to a variety of site conditions including topography, hydrology, and program.



WATER

- Utilize discrete drainage solutions, such as trench drains, along edges of paving to minimize the quilting of paved surfaces
- Use permeable surfaces where feasible based on soil and drainage characteristics
- Consider adjacent conditions, programming, and circulation in locating drainage structures; Avoid use of swales in these areas.
- Locate drainage structures within planting, rather than paving
- Provide irrigation to garden areas near seating; other areas to be evaluated with LSU



CANOPY

- Retain existing trees to provide shade for paving and furnished areas
- Add additional tree canopy where appropriate to reduce sun exposure
- Spaces below tree canopy should anticipate high levels of foot traffic
- Avoid planting trees where they may conflict with existing or future circulation routes & utilities
- Place mulch under tree canopy only where high levels of foot-traffic and use are anticipated



LIGHTING

- Use pole or bollard fixtures with appropriate light levels to create movement and rhythm for the space
- Provide a smooth transition between promenade and secondary paths
- Avoid obstacles in front of the light source
- Space lighting elements to provide adequate lighting at multiple groups of seating
- Associate banner signage with promenade light fixtures



GARDEN

- Gardens can be located along promenade and adjacent to paving
- Use garden to focus movement towards the main circulation path

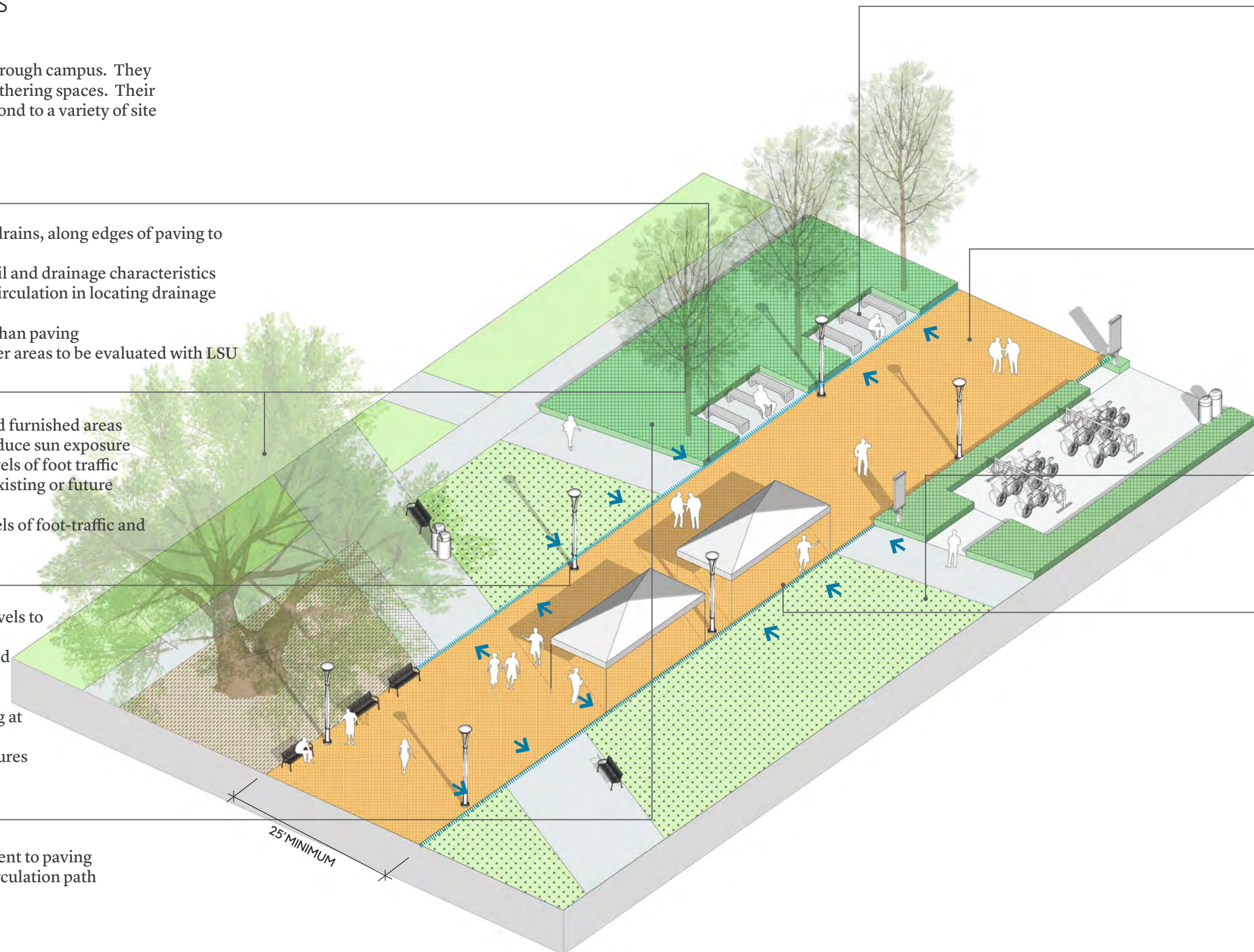



FURNISHING

- Locate seating and receptacles along the main circulation path
- Concentrate bike parking in designated areas off of the main path
- Prioritize seating in shaded areas and align benches to encourage gathering and people-watching
- Ensure signage is visible from major circulation route but does not have influence on amenity space
- Avoid flexible furnishings on the promenade
- Consider special elements such as banners on lights or unique signs used to suggest a continuous route through campus.



CIRCULATION

- Use consistent paving tone and patterns along promenades to improve wayfinding. Minor variations may happen at main plaza and entry spaces. Paving should be reinforced for vehicular loading
- Avoid interrupting promenade paving with secondary pathways
- Incorporate stormwater management along edges and avoid area drains within the mall
- Provide enough width for movement as well as gathering. Promenade should be wide enough for emergency vehicles to navigate without putting pedestrians in danger
- Provide flexible open space for tent and event uses



LAWN

- Use lawn to provide open views and overflow gathering spaces
- Avoid the use of lawn under dense canopy trees
- Consider reinforced lawn on two sides of promenade to accommodate game-day parking and event setup



TOPOGRAPHY

- Slope main circulation no more than 2% in any direction; Curb ramps should be the full width of the promenade
- Provide level shoulders at paving edges; Avoid using retaining walls next to major circulation
- Ensure intersecting paths and other areas of paving meet flush with the promenade
- Grade surface to move water off paving to edges and area drains in adjacent planted areas

MAJOREVENT CONSIDERATIONS

- Pedestrian promenades may serve as supplemental parking and vehicular circulation during events. Ensure controls are in place, such as temporary fencing, to prevent cars from traveling beyond intended parking areas
- Promenades may also host festival tents along the edge, allowing enough room for circulation



- ✓ Clearance on major circulation
- ✓ Vegetation providing shade
- ✓ A place for spontaneous event and gathering



- ✓ Special paving for major spine
- ✓ Different bench configurations to encourage different social activities
- ✓ View clearance to major building entrances
- ✓ Space to accommodate temporary events in different scales

2.2 CAMPUS LANDSCAPE TYPOLOGY GUIDELINES

PLAZAS

Plazas are primarily paved spaces that serve as entries to multiple buildings, major circulation routes, and gathering spaces. They should be designed to be flexible for a mix of program types. Shade is an important consideration to ensure plazas are comfortable and welcoming to users.



CANOPY

- Plant trees in arrangements that respond to the character of the space and that create shaded circulation and furnishing areas
- Scale trees used in plazas to allow clear circulation and program below the canopy
- Consider the soil implications of planting trees in paved areas



WATER

- Integrate trench drains at edges of paving and planting beds to simplify grading and to quickly move water off of paved areas
- Avoid pronounced “quilting” of paved surfaces where possible
- Use permeable surfaces where feasible based on soil and drainage characteristics.
- Consider quantity and characteristics of leaf /organic drop for ease of maintenance especially how it relates to site drainage.
- Provide irrigation to trees and garden areas in and around paving



LIGHTING

- Provide consistent pedestrian-scale lighting through plaza
- Utilize special lighting features in plaza spaces, with LSU approval
- Avoid high contrast lighting between plaza and adjacent spaces
- Coordinate adjacent building lighting to integrate building facade illumination into plaza design



TOPOGRAPHY

- Slope main surfaces to not exceed 2% pitch in any direction
- Utilize seat walls or steps to collect grade and define spaces within the plaza where significant grade change must be addressed

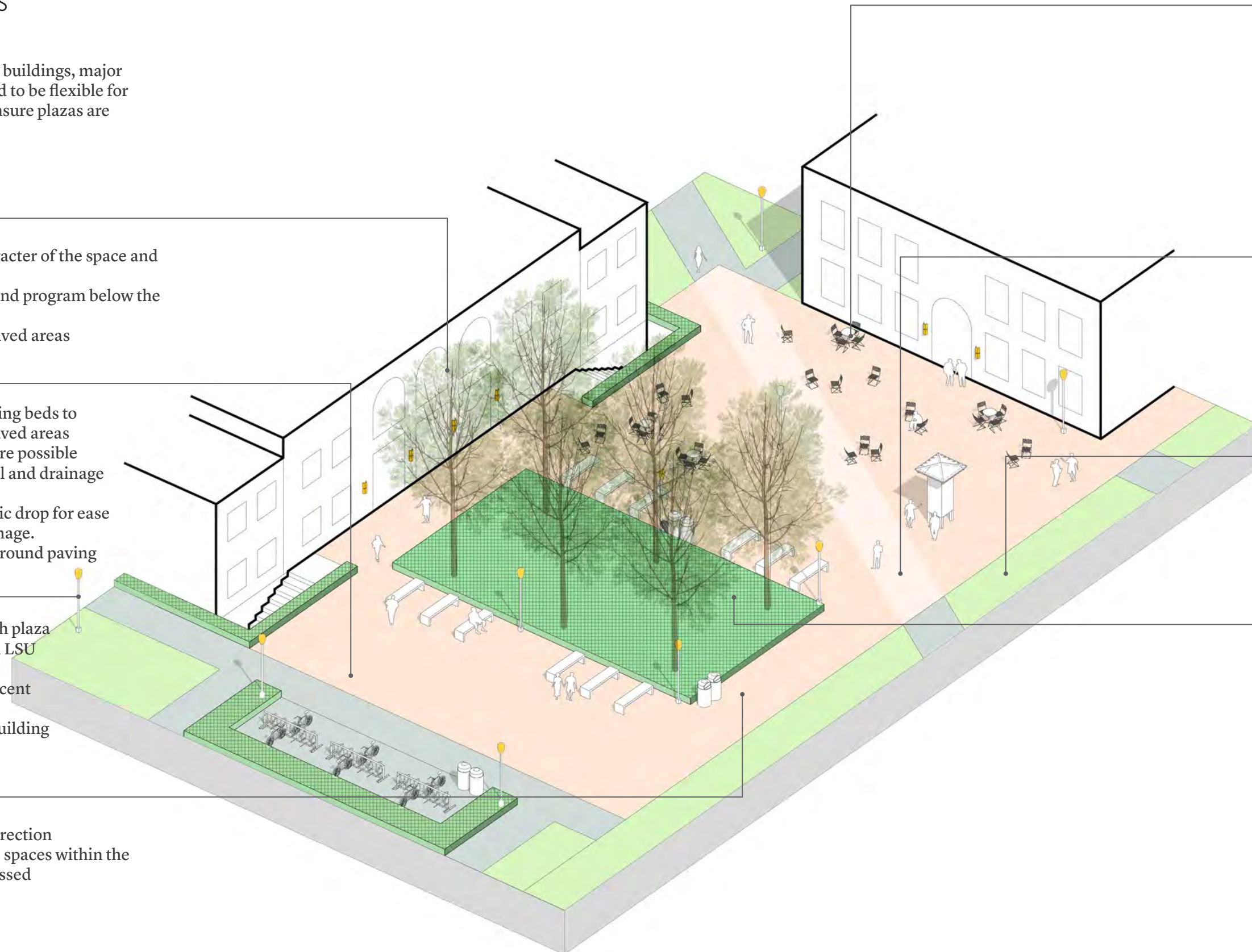



FURNISHING

- Provide seating, receptacles, bike parking and other amenities per anticipated programs' demand
- Keep main circulation routes and building entrances clear of furnishings
- Prioritize fixed seating in shaded areas
- Encourage movable seating and tables to promote flexibility and multiple uses in protected areas
- Install appropriate wayfinding at gateway spaces and ensure visibility from major circulation and entry points
- Consider bollards at plaza edges to control vehicular access



CIRCULATION

- Integrate the primary path into plaza paving pattern to emphasize primary circulation
- Direct movement along secondary paths towards the plaza and terminates at plaza paving
- Paving material at edges of plaza should highlight the boundary and indicate a transition to a different space
- Provide adequate flexible space for movement as well as event gathering
- Extend plaza paving to meet adjacent edge conditions
- Anticipate "short cutting" and design hardscape and landscape for intuitive walking and reduction of maintenance



LAWN

- Use lawn to promote open views into the plaza and create overflow gathering space
- Avoid the use of lawn below canopy trees



GARDEN

- Combine different shrubs and groundcover to enhance planting variety and seasonality
- Utilize garden where needed to direct pedestrian movement
- Create consistent masses of planting below tree canopy to create layers of vegetation, see Catalog for preferred spacing and configurations

MAJOREVENT CONSIDERATIONS

- Plazas are popular places for visitors to set up tents and tables because they are typically flat and paved. Ensure paved areas are sized appropriately to accommodate festival tents without restricting circulation routes
- Vehicle parking on entry plazas and adjacent planting should be avoided and be discouraged by use of design



- ✓ Clear circulations and view connections
- ✓ Furnitures selection based on campus landscape guideline
- ✗ Inappropriate canopy selection
- ✗ Should make bench setting be more conversational



- ✓ Canopy trees to provide shade
- ✓ A range of benches to encourage different types of social activities
- ✓ Spacial paving throughout the entire plaza

2.2 CAMPUS LANDSCAPE TYPOLOGY GUIDELINES

COURTYARDS

Courtyards are smaller campus spaces, typically enclosed on most or all sides by buildings, and are sometimes exterior spaces entirely within buildings. Courtyards function as gathering spaces for smaller groups, and often provide a quiet setting for study. Because these are often more internal spaces without larger campus contextual connections, there is more flexibility in their design expression.



WATER

- Incorporate trench drain along edges of paving
- Locate larger drain structures within planting
- Use rain gardens as an opportunity to collect building runoff; ensure water flows away from buildings
- Provide irrigation for all planted areas



CANOPY

- Select canopy trees that are appropriately scaled to the space
- Ornamental plantings that are unique to the courtyard can be incorporated



LIGHTING

- Highlight building entries with pedestrian scaled fixtures
- Consider unique lighting in response to architectural style of surrounding buildings must be approved by LSU



GARDEN

- Grow garden planting can be more elaborate, highlighting the full plant palette
- Consider micro-climates and impact of shade from surrounding buildings
- Utilize shade tolerant plants

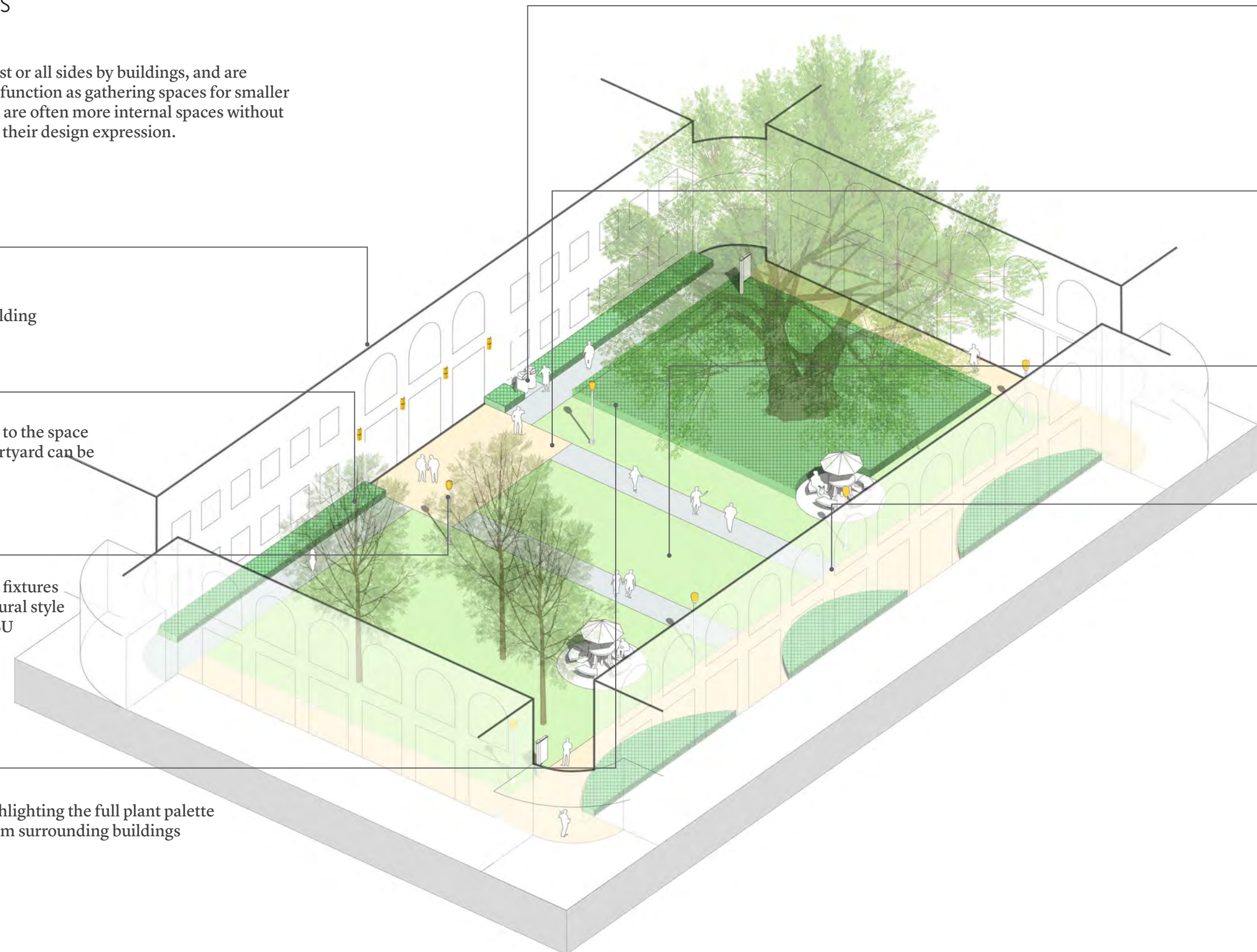



FURNISHING

- Consider multiple seating types and configuration; non-standard seating is acceptable with approval
- Scale signage to reflect the size of the space
- Consider ambient light from buildings in lighting design and fixture spacing
- Do not locate bike parking within courtyards
- Locate trash receptacles near building entries, but without congesting circulation



CIRCULATION

- Ensure that doorways are easily accessible and connected without over-paving the space
- Use special paving at key areas only; scale paving patterns appropriately to the scale of the space
- Consider alternate paving types, such as decomposed granite for smaller gathering spaces



LAWN

- Allow the scale and program of the courtyard to dictate how and if lawn should be used
- Consider a figural expression of lawn



TOPOGRAPHY

- Collect slopes into walls or steps when grade changes are present
- Ensure paving at building entrances meet flush with finished floor elevation to create a fully accessible courtyard

MAJOR EVENT CONSIDERATIONS

- Courtyard spaces are not appropriate spaces for vehicular tailgating and other large campus-wide events; they should be considered closed to the public during those times by adding controlled access elements



- ✓ Clear circulations and view connections
- ✓ Seating associates with canopy that provide shade
- ✓ Free movements between interior and exterior
- ✗ Too much reflection from concrete paving on ground
- ✗ Not following standard furniture selection



- ✓ Canopy trees to provide shade
- ✓ Providing chairs, picnic tables, bike racks to meet the uses of student life
- ✓ Flexible uses of in open space

2.2 CAMPUS LANDSCAPE TYPOLOGY GUIDELINES

QUADRANGLES

Quads serve as the iconic, formal spaces associated with major academic buildings on campus. They serve as ceremonial spaces, meant to symbolize the sense of communicative and academic exchange. Internal paths connect central academic buildings and direct other pedestrian traffic to other parts of campus.



CANOPY

- Use canopy to create shaded circulation and furnishing areas at the edges
- Provide canopy where necessary to scale buildings and create filtered experiences
- Maintain open space in middle of quad and under canopy for program



GARDEN

- Use garden under canopy trees where edges need to be defined to enhance pedestrian experiences
- Use groundcover at edges where need to control pedestrian movement
- Plant shrubs in masses, using a limited palette



LIGHTING

- Provide lighting along edges with building fixtures to define the space
- Carefully locate post lights along paths to avoid limiting flexibility in the center
- Avoid high contrast between various path and building light levels



WATER

- Use permeable path surfaces where feasible based on soil and drainage characteristics
- Locate drains in planted areas or edges of lawns to allow for convex landforms and avoid paving
- Use ground covers of other appropriate material at drain inlets as a leaf filter
- Provide dedicated irrigation to all planted areas and trees in paving

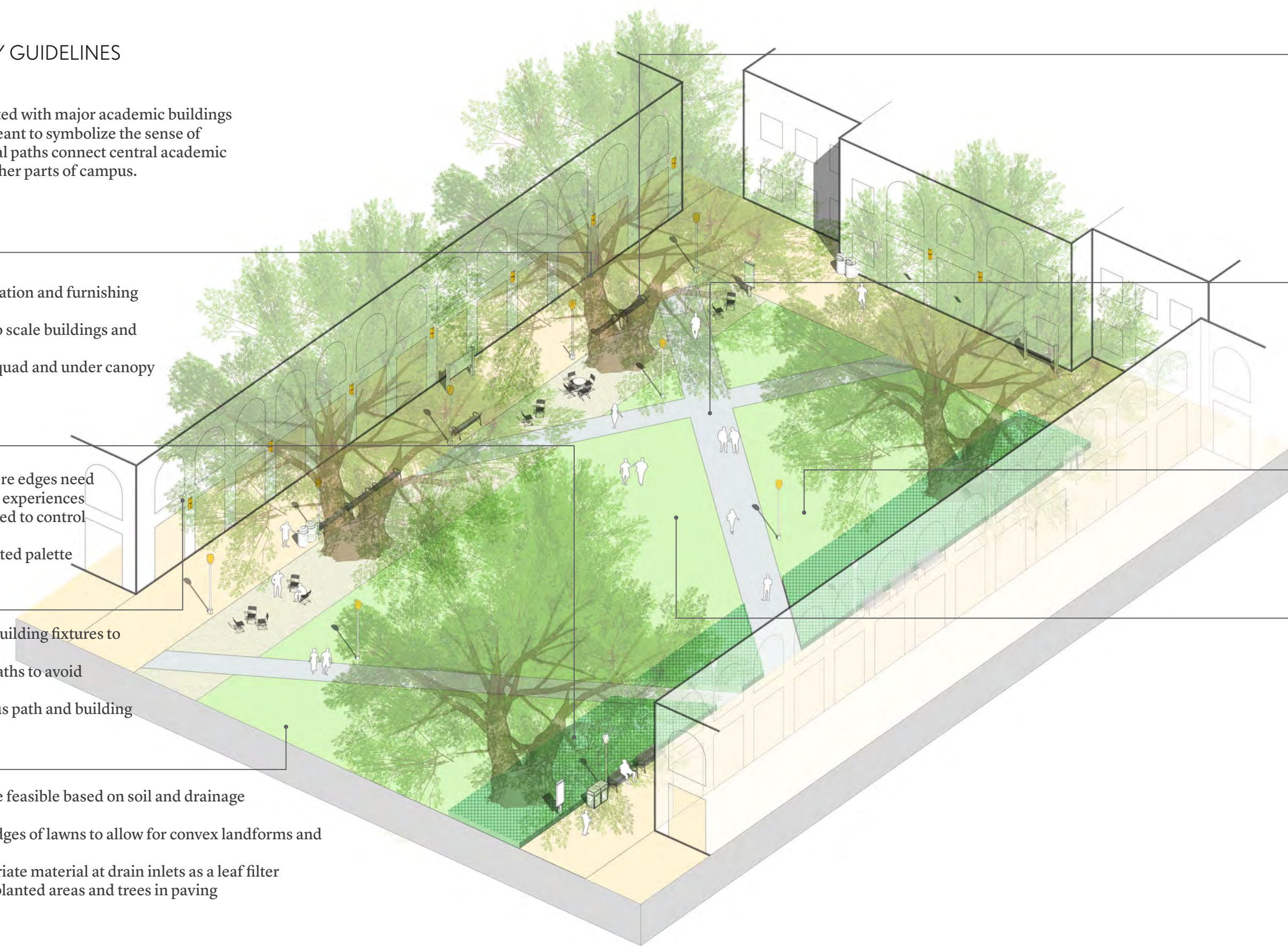



FURNISHING

- Locate seating and receptacles within the ‘amenity zone’ and away from building entrances
- Provide movable seating and tables for temporary use
- Prioritize seating in shaded areas
- Ensure signage is visible from major circulation routes but not in the center of the green space
- Do not locate bike parking within quads



CIRCULATION

- Organize paths to direct people out to campus circulation and connect major building entrance
- Ensure the clearance of view corridors along the paths in the quad
- Provide a flexible open surface for free movements and activities



LAWN

- Create large figural lawns within the center of the quad space
- Use reinforced lawn to support activity
- Locate new canopy trees carefully to avoid impacting flexibility of lawns at the center



TOPOGRAPHY

- Slope of main circulation should be no more than 2%
- Make consistent high points in the middle of quad to drain water to edges
- All the buildings around quad should provide accessible connections at major entrances

MAJOREVENT CONSIDERATIONS

- While major quad spaces are iconic to the LSU campus experience, main academic quad spaces should not be relied upon for major campus programming, such as tailgating.
- Smaller scale campus events, such as club tables or demonstrations, may be appropriate with LSU approval.



- ✗ *Planting bed blocks circulation*
- ✗ *Lack of circulation hierarchy*
- ✗ *Furnitures don't accommodate current uses*
- ✗ *Lack of large open space/view*



- ✓ *Open space in major building entrance*
- ✓ *Activities are along the edges*
- ✗ *Lack of garden planting under live oak*
- ✗ *Lack of view corridor along building facade*



- ✓ *Canopy providing shade to seating along the edge*
- ✓ *Special garden species to emphasize building entrance*
- ✓ *Free movements and open views*
- ✓ *Materials consistency*
- ✓ *Drainage on the edge*

2.2 CAMPUS LANDSCAPE TYPOLOGY GUIDELINES

GREENS

Greens are large open lawns defined by buildings and internal campus roads. Ample amounts of lawn are left open to accommodate flexible events and are typically dotted with canopy trees to provide shade. Greens are differentiated from quads by their scale, informality, and flexibility. They are accessible by multiple modes of circulation.



CANOPY

- Use existing canopy where possible to create shaded circulation and furnishing areas
- Provide canopy where necessary to scale buildings and create filtered experiences
- Avoid detailed planting beds. Ground cover or sustainable mass plantings can be used at key locations next to hard surfacing.



GARDEN

- Use mulch under canopy trees to allow for flexible circulation and anticipated levels of high use
- Use groundcover at edges where needed to control movement



LIGHTING

- Provide light along major circulation routes
- Light the boundaries to define the green space with building fixtures
- Avoid high contrast lighting between different path fixtures and building lighting



WATER

- Utilize trench drain along edges of green to simplify grading and manage runoff
- Use permeable path surfaces where feasible based on soil and drainage characteristics. On large lawns, subdrainage systems should be used to avoid open area drains and pronounced quilting
- Provide water lines and quick couplers for supplemental irrigation; provide temporary irrigation at new trees

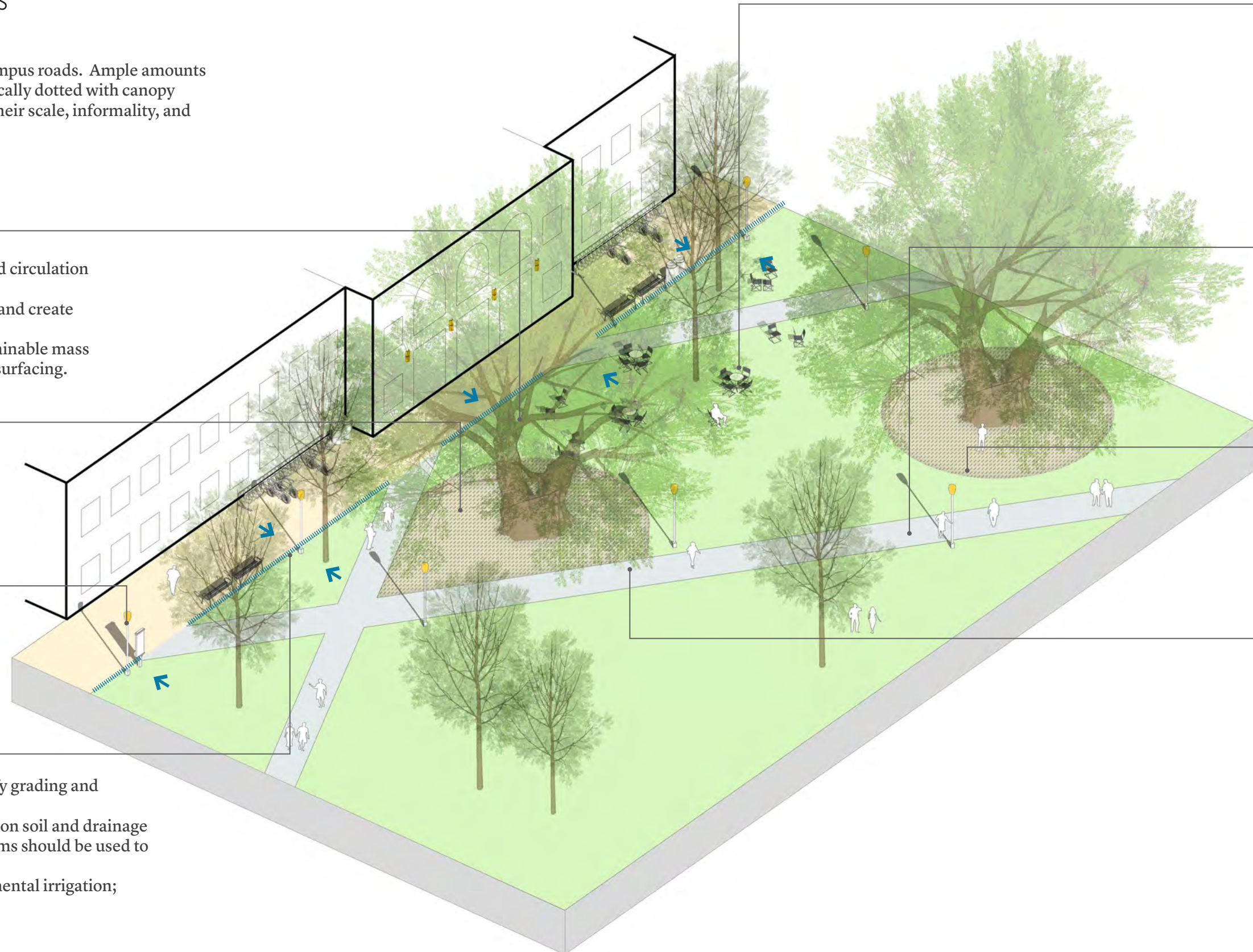



FURNISHING

- Provide fixed seating, receptacles, bike parking along edges
- Provide movable seating and tables for use in lawns and other open spaces
- Prioritize seating in shaded areas if possible
- Ensure signage is visible from major circulation routes, but is not located in the center of green space



CIRCULATION

- Use paths to direct people to primary campus circulation
- Maintain open space for event and activity purposes



LAWN

- Shape lawn as the major spatial and figural element
- Utilize reinforced lawn in areas that anticipate high levels of use
- Avoid to use of lawn below large canopy trees where roots or shade will impact turf quality



TOPOGRAPHY

- Construct slope of main circulation no more than 2%
- Make consistent high points in the middle of green to drain water to edges
- Provide accessible connections to major entrances of all buildings via ramps if necessary

MAJOR EVENT CONSIDERATIONS

- Campus greens provide for flexibility for major campus-wide events.
- They allow for easy access to larger circulation routes and while providing open space for tailgating and gathering.



- ✓ Use lawn and mulch to allow free movements on the green
- ✓ Canopy tree planting to provide shade
- ✓ Open view connections
- ✗ Lack of the circulation hierarchy
- ✗ Lack of seating

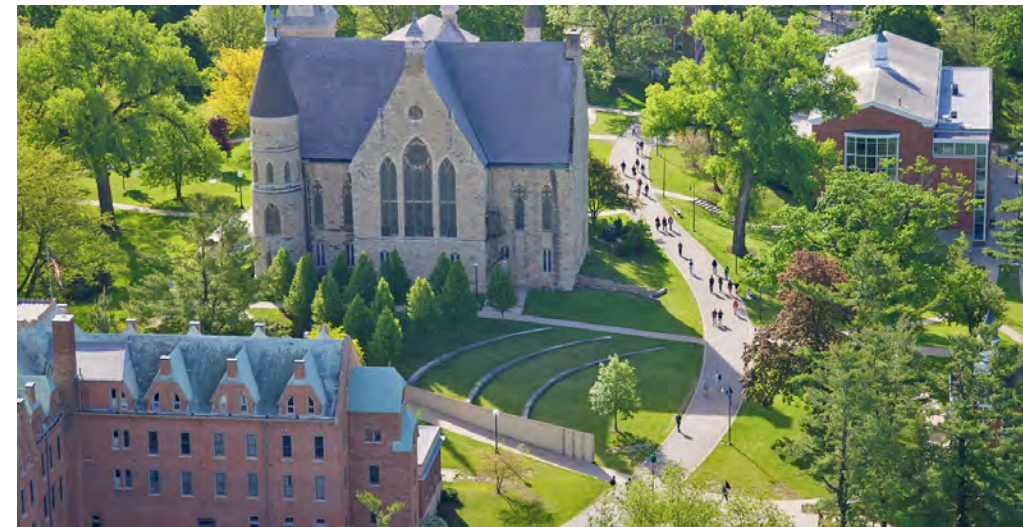

- ✓ Green as the foreground for major buildings
- ✓ View clearance from building to building
- ✓ Using lawn for free movements
- ✓ Vegetation selection for different seasons



- ✓ Clear circulation hierarchy
- ✓ Large open lawn for free movements and gatherings
- ✓ Canopy trees providing shade and framing spaces

2.2 CAMPUS LANDSCAPE TYPOLOGY GUIDELINES

HABITAT

Habitat areas create a strong sense of place and connection to the regional ecology. Historically limited to functional performance, contemporary uses incorporate recreation and stormwater to provide ecological and aesthetic value. They serve as interesting and distinctive ways to cross-campus connections.



CANOPY

- Use canopy to create shaded circulation and furnishing areas at the edge of paths
- Provide canopy where necessary to scale buildings and create filtered experiences
- Arrange new planting to create various scales of open space to support flexible programming
- Plant a mix of tree species to improve biodiversity and habitat health



GARDEN

- Use a diverse plant palette that reflects the natural ecology
- Planting should be less structured, contrasting more formal areas of campus
- Select plants for their durability and resilience to respond to dynamic conditions and minimize maintenance



LIGHTING

- Keep lighting related to primary circulation
- Space fixtures accordingly to provide safe light levels without over-lighting the area



WATER

- Capitalize on large detention areas and natural depressions to hold and absorb stormwater during rain events
- Maintain a 'soft' edge along streams, creeks, and other hydrologic features to allow for filtering of stormwater
- Avoid plantings that require irrigation in these areas

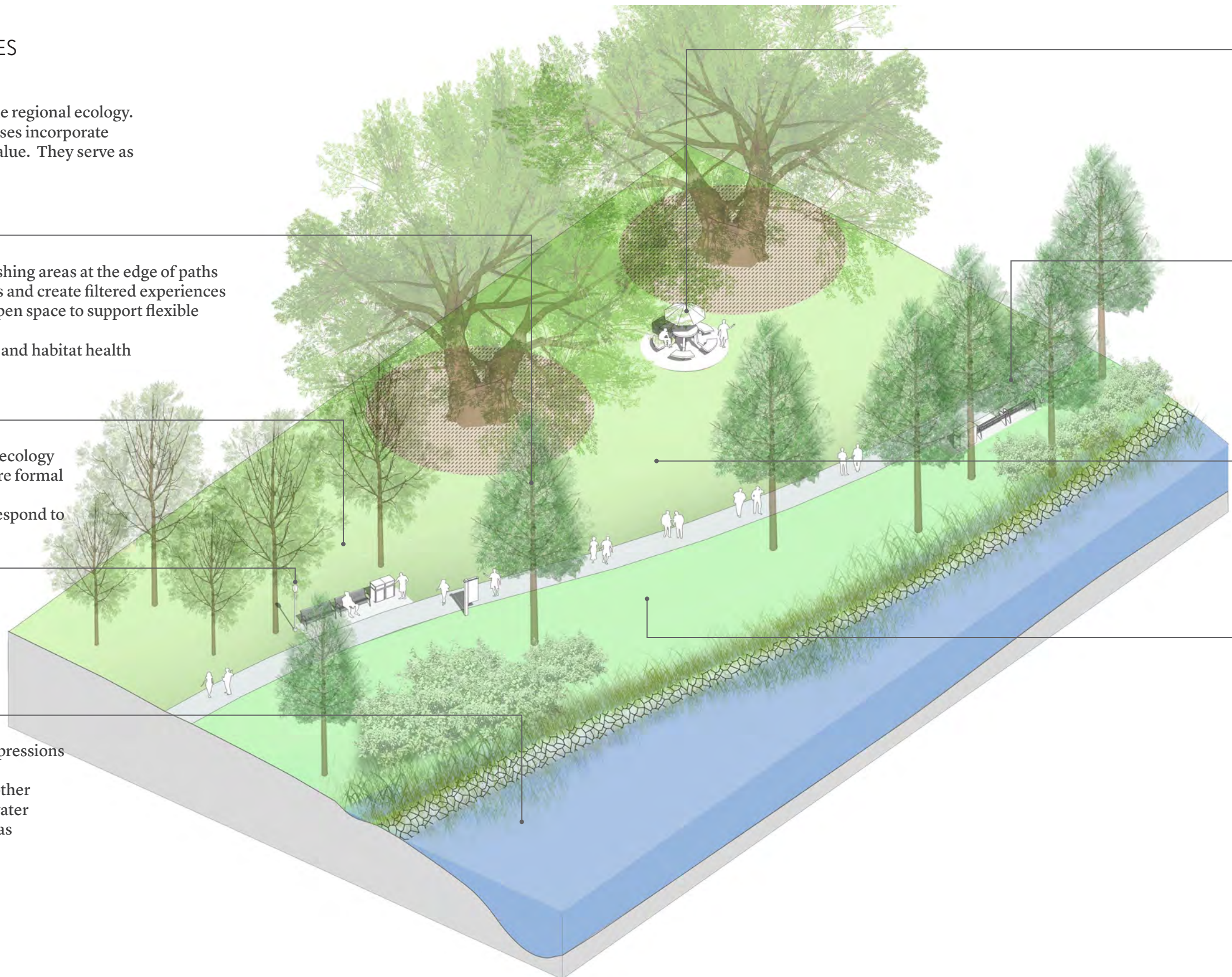



FURNISHING

- Group seating, receptacles, and lighting along main circulation route
- Provide movable seating and tables for temporary uses
- Prioritize seating in shaded areas



CIRCULATION

- Relate circulation to natural topography and water
- Creating larger campus connections through habitat areas less related to specific building entries
- Hold vehicular access away parking from areas surrounding these resources



LAWN

- Use reinforced lawn to accommodate flexible circulation use adjacent to habitat areas
- Consider low-maintenance plantings for large areas of habitat such as meadow, grassland, or no-mow alternatives



TOPOGRAPHY

- Utilize circulation and hydrology to support and highlight natural topography of the area
- Stabilize steep slopes with appropriate planting of limestone rip rap or architectural structures

MAJOREVENT CONSIDERATIONS

- Select habitat areas can be used for larger gatherings, but best serve the campus by providing larger cross-campus connections.



- X *Parking needs to setback from water edge*
- X *No pedestrian circulation and activities along water*
- X *Lack of vegetation diversity*



- ✓ *Canopy trees along circulation to provide shade*
- ✓ *Diversified vegetation for erosion control and habitat*
- ✓ *Good combination of open lawn and groundcover*

2.2 CAMPUS LANDSCAPE TYPOLOGY GUIDELINES

CORRIDORS

Often providing back-of-house or service functions, exterior corridors exist throughout campus. These spaces are often overlooked as merely circulation areas, but can often be used for bicycle parking and small gathering spaces.



CANOPY

- Use species that are upright to create shaded spaces, and understory or ornamental trees to screen utilities.
- Protect existing mature and healthy trees from encroachment by paving or furnishings



GARDEN

- Limit the use of garden plants to groundcovers and short shrubs to avoid creating blind spots behind vegetation
- Utilize shade tolerant species for narrow spaces and corners
- Low shrubs may be used to screen utilities and amenities within corridors



LAWN

- Use lawn sparingly in corridor spaces, primarily adjacent to the primary pathway to allow for increases in circulation capacity during heavily trafficked times



WATER

- Pitch paving surfaces outward to area drains in planted areas.
- Use appropriate drain screens in plantings
- Use plants with low water needs in these spaces as irrigating narrow strips of shrubs or lawn is difficult and may be expensive
- Provide temporary irrigation to garden areas and new trees where necessary for establishment

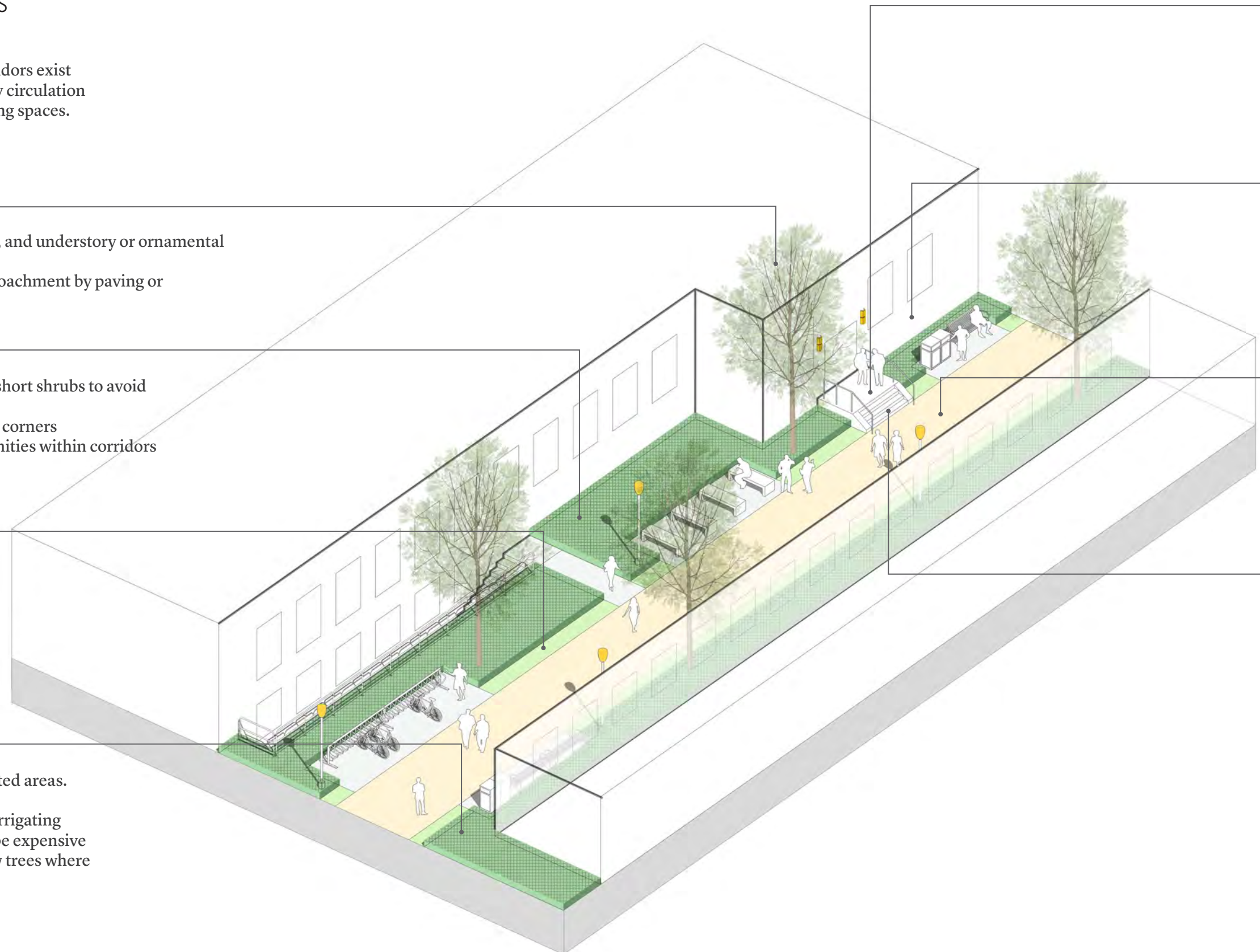



FURNISHING

- Locate furnishings such as benches, bicycle racks, and trash receptacles in corridors to take advantage of their scale, available shade, and relatively utilitarian character
- Locate trash receptacles away from intersections with major pathways
- Larger areas of furnishings, such as small plazas for movable seating, may be located in corridors where program and agencies allow for their use
- All furnishings should be located off of the main pathway to avoid circulation conflicts



LIGHTING

- Gradually reduce light levels at end points of pathways to ensure smooth visual adaptation for pedestrians from brighter light level zones
- Use pedestrian scale light fixture to provide adequate light levels along alleys to ensure perception of safety
- Consider vertical illumination of building surfaces at destinations or end points to enhance wayfinding and the perception of safety



CIRCULATION

- Provide a primary, uninterrupted path of either unit or concrete paving through corridor spaces
- Primary pathways must be a minimum of 8' wide but 12'-16' is recommended for highly trafficked areas
- Avoid placing furnishings within the main pathway
- Secondary pathways should intersect but not interrupt the main pathway



TOPOGRAPHY

- Cross slopes on pathways may not exceed 2%
- Grade primary paths through corridor spaces to create flush building entry conditions where possible
- Where entries must be at a different elevation than the primary path, provide accessible connections outside of, and adjacent to, the primary pathway

MAJOR EVENT CONSIDERATIONS

- Corridor spaces are often hotspots for undesirable or illegal activities. Care should be taken to minimize hidden corners or pockets for these activities to take place.
- Keep primary pathways clear of supplemental trash receptacles or temporary fencing
- Generally tailgating should not be allowed in this spaces as it may inhibit circulation.



- ✗ No screening for dumpsters and other facilities
- ✗ No clearance on view and circulation
- ✗ No vegetation covering



- ✗ Obstacles on major circulation
- ✗ Lack of seating and bike racks as student life amenities
- ✗ Path is too narrow for circulation demands
- ✗ Large shrubs create blind spots



- ✓ Clear view connection and circulation corridor
- ✓ Organized bike racks
- ✓ Garden to screen bike racks and create layers of vegetation
- ✓ Canopy trees that provide shade

2.2 CAMPUS LANDSCAPE TYPOLOGY GUIDELINES

SERVICE AREAS

Service areas include areas for loading, trash and recycling, maintenance parking, and other infrastructure and equipment storage. Because most buildings on campus do not have a true “back-of-house”, these spaces are often used by pedestrians as shortcuts or even major circulation routes.



CANOPY

- Use canopy to create shaded circulation and furnishing areas at the edges
- Provide canopy where necessary to scale buildings and create filtered experiences



GARDEN

- Use garden under canopy trees to define the edges and enhance pedestrian experiences
- Use groundcover at edges where needed to control the circulation



LIGHTING

- Use fixtures with good cutoff to minimize light pollution and glare to adjacent spaces
- Provide increased light levels at building entries, pedestrian pathways intersecting service areas and pedestrian crossings to ensure safety



WATER

- Utilize trench drain along edges of softscape to simplify grading and manage water off to regional drainage system
- Use permeable path surfaces where feasible based on soil and drainage characteristics
- Consider management of vehicle and trash runoff and its impact on vegetation
- Provide temporary irrigation to garden areas and new trees where necessary for establishment

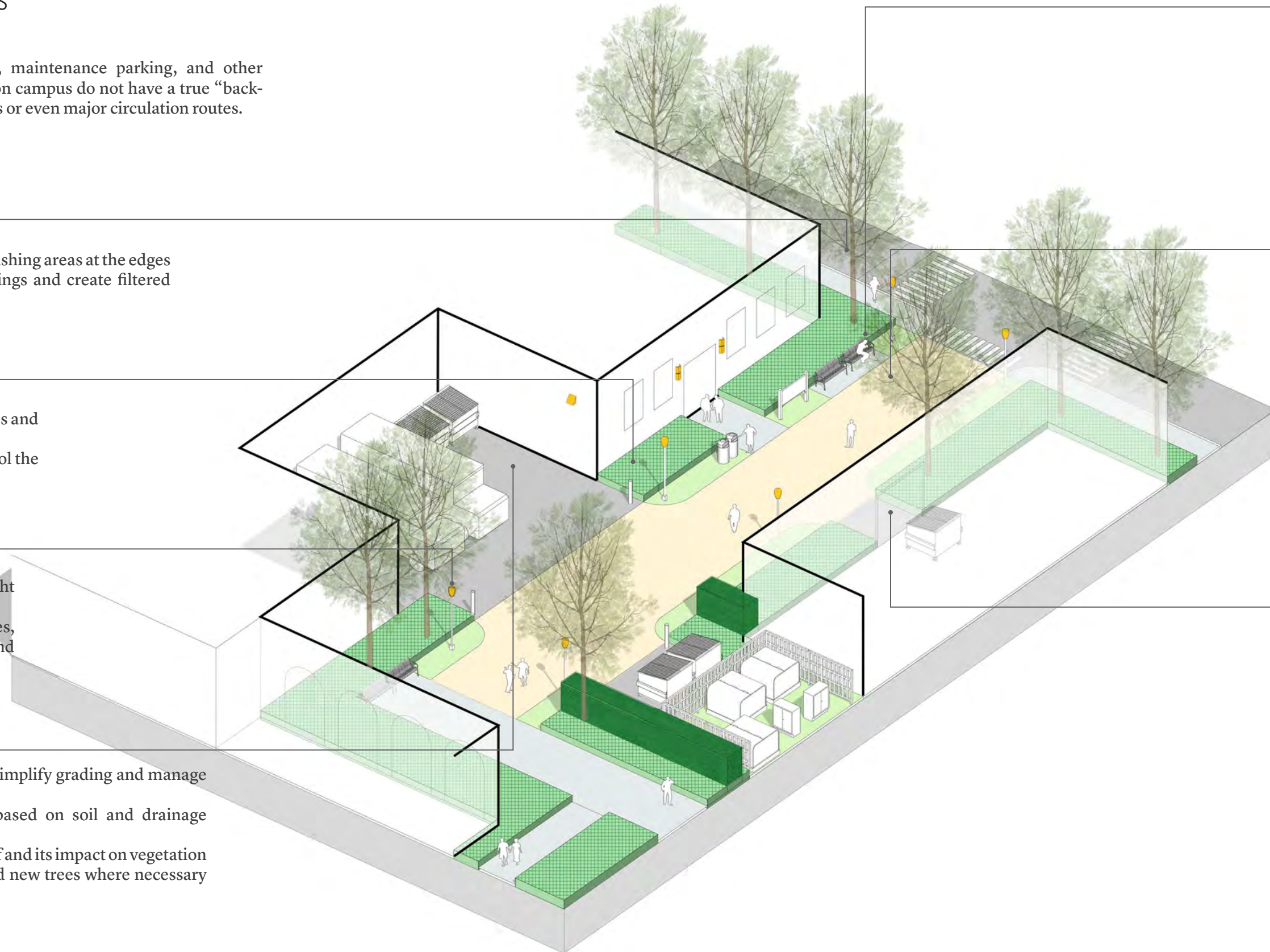



FURNISHING

- Provide seating, receptacles, bike parking close to major building entrances
- Consider the experience of users when locating furnishings and avoid locating seating near or facing loud equipment, dumpsters, or frequently-idling vehicles
- Signage should indicate to drivers that pedestrians have the right of way in service areas
- Use bollards selectively to protect furnishings and other vulnerable elements from damage by vehicular traffic



CIRCULATION

- Paved areas should be designed to accommodate pedestrian circulation primarily and vehicular or service circulation secondarily
- Differentiate main pedestrian corridors (building entry/plaza paving) and strictly-service areas (concrete or asphalt) through paving materials
- Use appropriate paving details for surfaces that are to receive vehicular traffic



LAWN

- Large areas of lawn use should be minimized in service areas except where equipment or storage requires frequent access
- Reinforced lawn may be used at edges of paving and gardens to provide additional turn and circulation space



TOPOGRAPHY

- Slope of main circulation should be no more than 2%
- Avoid locating major drain structures in paving

MAJOREVENT CONSIDERATIONS

- Many service areas on campus also double as game-day or event parking. Where possible, design spaces to accommodate some parking for events while maintaining sufficient space for circulation and emergency access.
- Service areas often include loading docks, dumpster areas, and exterior equipment. These spaces become targets for undesirable activity. When planning and designing around service areas, consider ways to use vegetation or temporary fencing to discourage these types of activities.
- Designate maintenance parking in the areas



- ✗ Vehicular paving takes the entire space
- ✗ No canopy to provide shade
- ✗ Spaces needed on major building entrances
- ✗ sidewalks are not large enough to accommodate intensity of foot traffic



- ✓ Special paving for pedestrian moves
- ✓ Clear signs for loading area
- ✓ Bollards protect benches
- ✓ Vegetation used to create inviting spaces for pedestrians



- ✓ Screening to block direct view to utilities
- ✓ Combination of vegetation and fence to control through traffic

2.2 CAMPUS LANDSCAPE TYPOLOGY GUIDELINES

SURFACE PARKING

Surface parking on campus occurs in many scales and conditions. These guidelines represent best practices for all surface parking lots; however, designers should work with University staff to determine the specific features and approach to each new parking lot and renovation.



CANOPY

- Provide canopy to shade parking and pedestrian paths
- Protect existing trees, providing adequate soil volume and space
- Use mulch under existing canopy trees
- Select trees for durability in a compact planter island



GARDEN

- Limit garden planting to vegetated swales and stormwater detention areas
- Utilize minimal to no irrigation in these areas



LIGHTING

- Use vehicular scale lighting for parking areas
- Keep smaller-scale light fixtures related to main pedestrian routes



WATER

- Create swales or rain gardens at low points to collect surface runoff
- Locate wheel stops along swales
- Utilize permeable asphalt where possible
- Avoid plantings that require irrigation in these areas. Provide infrastructure necessary to hand water plants during establishment

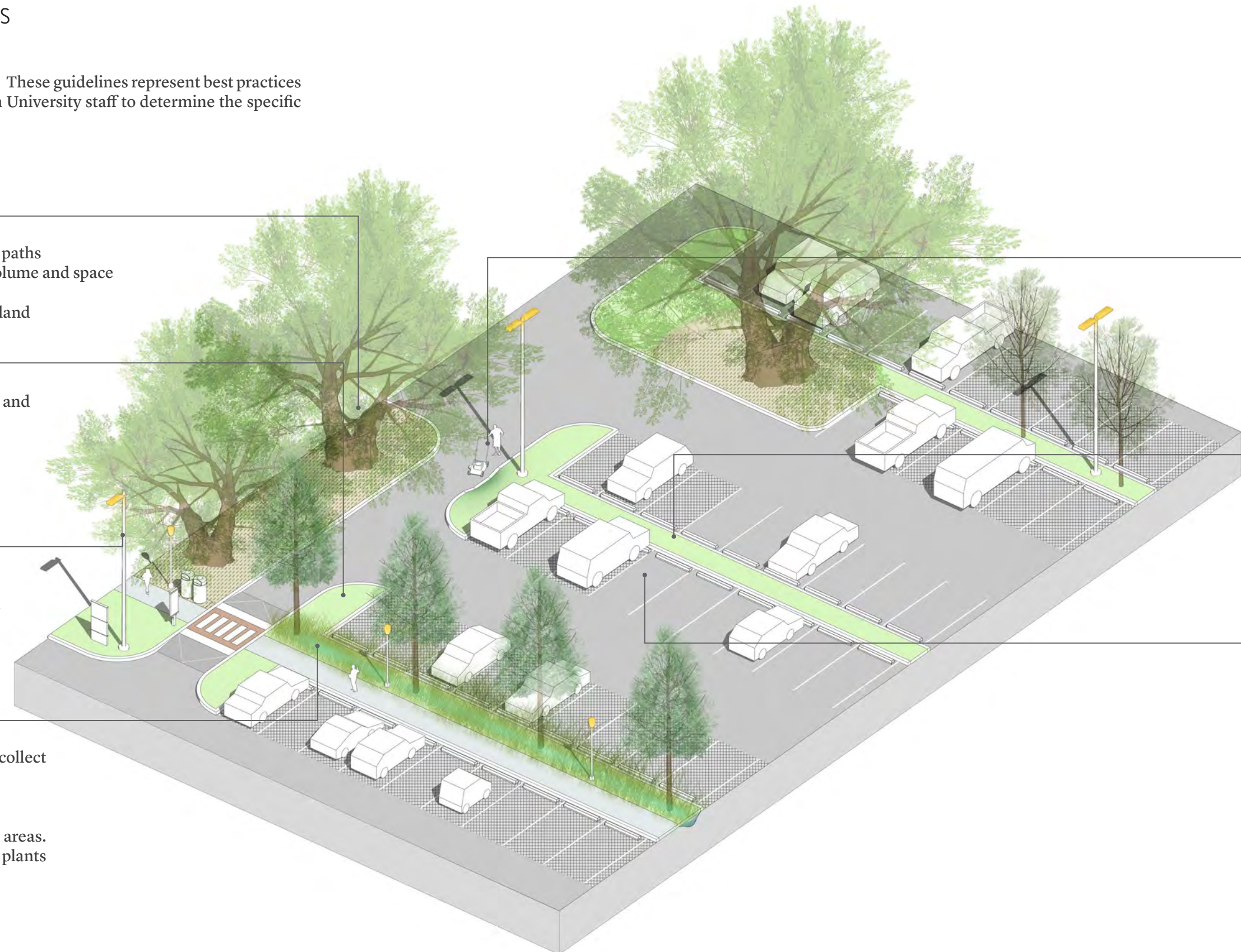



FURNISHING

- Locate trash receptacles and signage along main pedestrian routes
- Minimal seating required in large surface parking zones



CIRCULATION

- Provide tabled and marked crosswalks at key pedestrian connections
- Minimize pedestrian - vehicular conflicts
- Provide adequate access for maintenance personnel and equipment



LAWN

- Prioritize lawn over garden planting to minimize maintenance efforts
- Consider low-maintenance plantings such as meadow, grassland, or no-mow alternatives where appropriate



TOPOGRAPHY

- Slope of main pedestrian circulation should be no more than 2%
- Create high points to direct water towards swales and drainage structures

MAJOR EVENT CONSIDERATIONS

- Surface parking provides ample space for tailgating and extra large event gatherings due to surface area available.
- Sensitivity to existing canopy trees should be considered in event setup and access.



- ✗ Massive parking area without canopy that provides shade
- ✗ No stormwater management on site
- ✗ No signage for directions



- ✓ Stormwater management associates with parking
- ✓ Pedestrian circulation is separated out from vehicular routes
- ✓ Canopy trees that provide shade

- ✓ Frequent canopy trees that provide shade
- ✓ Primary planted surface is lawn

2.2 CAMPUS LANDSCAPE TYPOLOGY GUIDELINES

THRUWAYS

Thruways are major roads that cross through campus and carry a mix of university and general public traffic. They are typically two to four lanes of traffic and are not appropriate for bicycle lanes or parking within the road profile.



CANOPY

- Protect the root zone of existing canopy trees
- Continue lines of Live Oak trees where existing; integrate additional canopy trees in newer zones
- Utilize permeable paving and/or structural soil under large tree canopies where compaction may occur



GARDEN

- Locate masses of shrubs and groundcover to deter cut-throughs in high traffic areas
- Vegetated buffers provide separation between vehicular and bike traffic



LIGHTING

- Keep larger roadway fixtures related to vehicular circulation
- Utilize smaller fixtures along pedestrian paths
- Provide flashing crosswalk lighting at major crossings



WATER

- Capitalize on stormwater management opportunities along street edges
- Avoid plantings that require irrigation in these areas. Provide infrastructure necessary to hand water plants during establishment

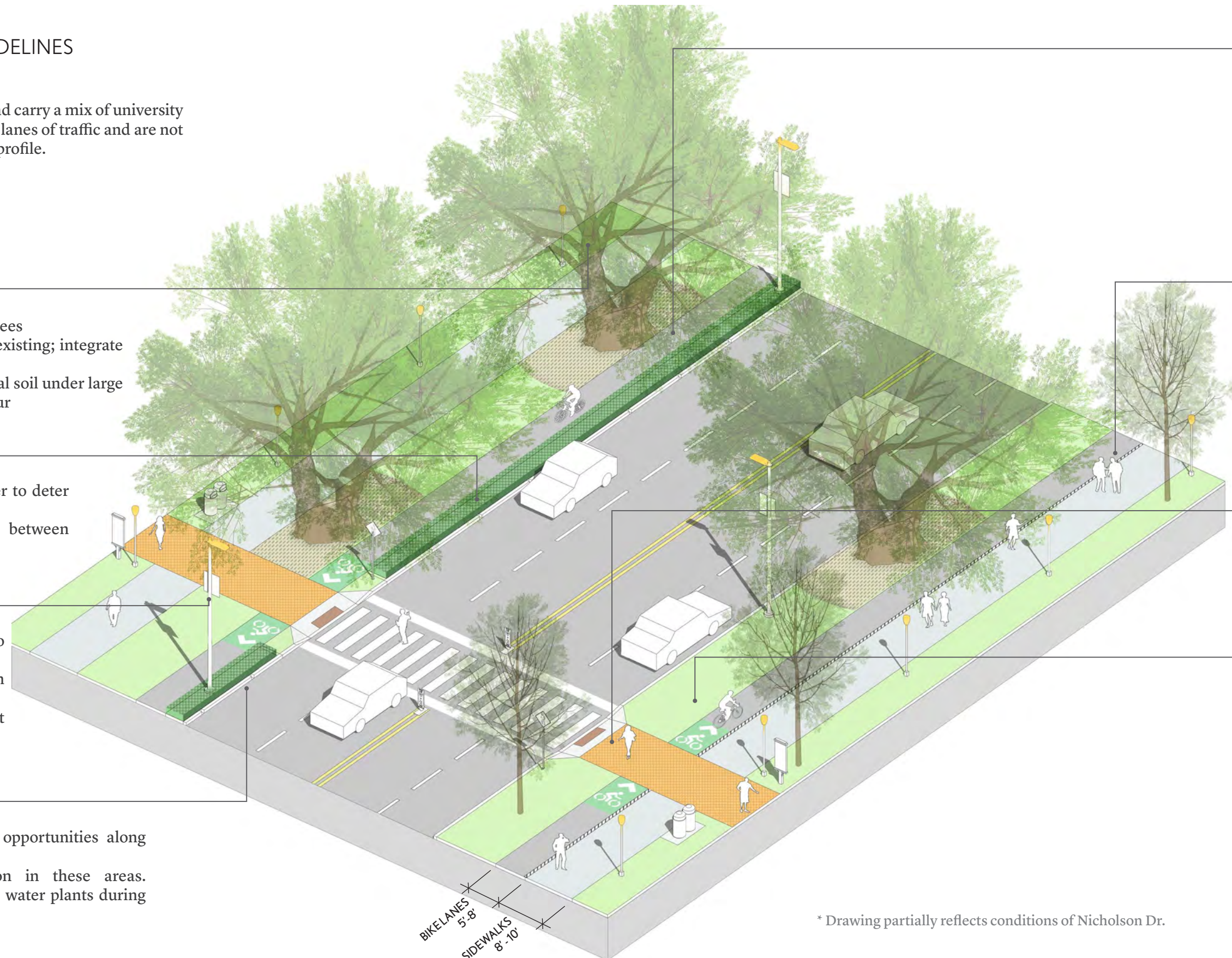



FURNISHING

- Provide benches at regular intervals in shaded areas
- Locate trash receptacles near intersections, offset 10'-20' from the sidewalk intersection
- Provide wayfinding at major intersections
- Integrate banner signage into vehicular lighting along the roadway



CIRCULATION

- Offset sidewalks from road way and canopy trees to provide separate and comfortable pedestrian circulation
- Provide clear separation between multiple modes of transportation
- Provide buffer or material change between bikes and pedestrians
- Clearly mark locations where pedestrian circulation crosses other modes
- Provide elevated crosswalks wherever possible



TOPOGRAPHY

- Slope of main circulation should be no more than 2%
- Provide curb cuts at pedestrian crosswalks for ADA circulation



LAWN

- Use lawn as verge surface material in sunny areas or where garden and mulch are not appropriate

MAJOREVENT CONSIDERATIONS

- Thruways are not appropriate spaces for event gathering
- Vehicular access should remain clear during major campus events for efficient circulation



- X *Narrow sidewalks tight against roadway*
- X *lighting scaled for vehicles and note pedestrians*
- X *no seating or amenities provided*



- X *No sidewalks or bike lanes provided*
- X *no shade near roadway*
- X *wide lanes encourage higher travel speeds*



- ✓ *Pedestrian circulation buffered from vehicles and parallel parking*
- ✓ *signage appropriately sized for context*
- ✓ *walks shaded by tree canopy*
- ✓ *lighting appropriately scaled and located adjacent to path*

2.2 CAMPUS LANDSCAPE TYPOLOGY GUIDELINES

INTERNAL ROADS

Internal roads are typically 1 or 2-way streets with no more than two primary lanes. They carry campus-related traffic and are often restricted to vehicles with appropriate parking passes.



CANOPY

- Many campus roads have an existing tree canopy that should be protected during any construction activities
- Plant new trees appropriate for streets in areas where trees are lacking to provide shade for paved surfaces
- Sidewalks impacting tree root zones should be designed as permeable surfaces



GARDEN

- Limit garden use to mass-planting groundcover and stormwater management plantings along road edges
- Groundcovers and small shrubs may be used to deter mid-block crossings in high-traffic areas



LAWN

- Lawn may be used as a buffer between busy roads and sidewalks, however it does not help prevent mid-block crossings
- Grade lawns to avoid draining large areas across sidewalks



WATER

- Make efforts to slow and capture roadway runoff in swales and rain gardens before overflowing into storm drains
- Avoid plantings that require irrigation in these areas. Provide infrastructure necessary to hand water plants during establishment

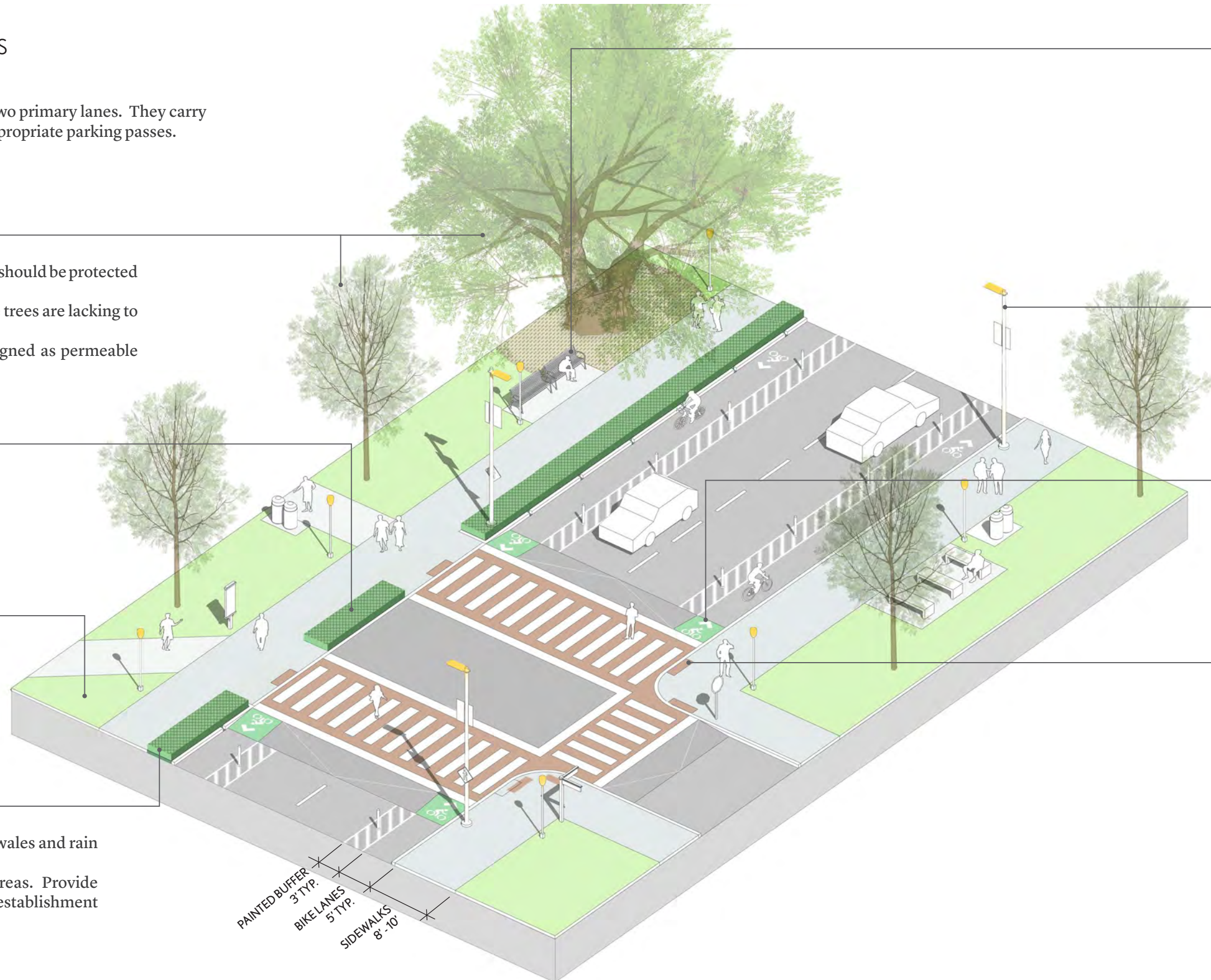



FURNISHING

- Provide adequate flexible seating at bus stops along campus roads, even where a shelter may not be provided
- Locate trash and recycling receptacles near major roadway and path intersections. Ensure enough spaces is available to avoid conflicts between furnishings and pedestrians in high-traffic areas
- Locate building and vehicular signs so that they are visible by passing cars without creating dangerous blind spots for drivers or pedestrians
- Utilize pedestrian-activated crossing lights at major pedestrian crossings.
- On busy routes, selectively locate benches in shaded areas, especially on long stretches of sidewalk



LIGHTING

- Where feasible, locate vehicular-scale fixtures along road edges and pedestrian-scale fixtures along sidewalks.
- Some road conditions and retrofits may use the vehicular-scale lantern style fixture to illuminate both roadways and sidewalks
- Banners may be attached to vehicular fixtures



CIRCULATION

- Provide clearly marked crosswalks at major path intersections with roads
- Provide bicycle facilities on both sides of streets, often replacing parallel parking.
- Carefully integrate various pedestrian and vehicular transit modes to avoid dangerous conflicts between users.
- Sidewalks may either abut road edges or be offset with a verge planting of lawn, groundcover, or stormwater management plantings
- Provide elevated crosswalks wherever possible



TOPOGRAPHY

- Speed tables help to calm traffic and provide easier crossings for pedestrians
- Ensure all curb ramps and sidewalk cross-slopes meet ADA requirements

MAJOR EVENT CONSIDERATIONS

- Bicycle lanes along campus roads may be converted to temporary event parking to maximize parking capacity.
- Use bollards or temporary event fencing where necessary to prevent vehicles from leaving roadways and driving onto lawn and garden areas, or over tree roots.
- Provide additional temporary trash receptacles along major pedestrian routes.



- ✓ Clear signage and wayfinding
- ✓ Sidewalks shaded by tree canopy
- ✓ Bike lanes painted in both directions
- ✓ Clearly marked cross walks



- ✓ generous sidewalks and no parallel parking provides ample space for pedestrians and bikes
- ✓ shade provided by canopy trees
- ✓ mulch used below live oaks in high-traffic areas
- ✗ few amenities provided along sidewalks



- ✓ Shelter provided at bus stop
- ✗ furnishings crowd bus stop seating
- ✗ steps between sidewalk and shelter don't allow accessible use of the bus stop shelter

3.0 MATERIAL AND COMPONENT CATALOG



3.1 CIRCULATION

- STREETS & SIDEWALKS
- CROSSWALKS & CURB RAMPS
- PATHWAYS
- PAVING



3.2 FURNISHING

- BENCHES
- SEATS & TABLES
- LITTER RECEPTACLES
- BIKE RACKS
- BOLLARDS
- SCREENING & FENCES
- ART & WAYFINDING



3.3 LIGHTING

- PEDESTRIAN POLES
- ROADWAY & PARKING POLES
- ILLUMINATED BOLLARDS
- ACCENT & UP-LIGHTING
- EMBEDDED LIGHTS
- WALL-MOUNTED LIGHTS
- CEILING LIGHTS
- RECOMMENDED LEVELS



3.4 TOPOGRAPHY

- LANDFORM & SOIL TYPES
- RAMPS & SLOPED WALKS
- STAIRS & RAILINGS
- SITE WALLS



3.5 WATER

- HYDROLOGY
- STORM WATER COLLECTION
- IRRIGATION



3.6 CANOPY

- LIVE OAK
- CANOPY & EVERGREEN TREES
- ORNAMENTAL & PALM TREES



3.7 GARDEN

- SHRUBS
- PERENNIALS
- ORNAMENTAL GRASSES
- GROUNDCOVERS



3.8 LAWN



3.1 CIRCULATION

STREETS & SIDEWALKS

DESIGN RATIONALE

Much of the pedestrian circulation system on campus is organized around the road network. Sidewalks, promenades, bike lanes, and other pathways create a network of pedestrian movement that frequently encounters and must coexist with vehicular traffic. The way pedestrians experience these moments and spaces significantly impact the perception of quality and safety on campus. To meet the Master Plan objectives of prioritizing the pedestrian experience and promoting alternate means of commuting and travel, designers working on campus should strive to create comfortable and predictable interactions with vehicles through consistent street, streetscape, and sidewalk design. These guidelines must be considered and applied to a variety of street conditions. All proposed streetscape designs shall be reviewed and coordinated with LSU and the project Civil and Traffic engineers.

LSU Campus Standard roadway section shall consist of 2 - 11' travel lanes, 2 - 5' bike lanes, and 2 - 8' sidewalks. On-street parking (parallel, angled, or perpendicular) is not allowed on new construction. Existing on-street parking is being eliminated as new parking lots are being constructed. Where on-street parking is eliminated, the existing pavement shall be used to develop bike lanes and reconstruct sidewalks to meet the minimum 8' standard. Drainage shall be modified as needed.

TYPICAL ROADWAY PROFILES

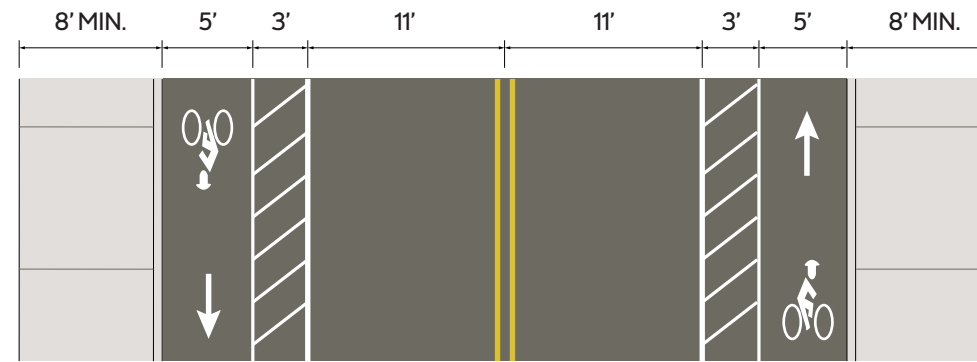

The preferred roadway cross section for internal campus roads includes bike lanes in both directions with a striped buffer zone.

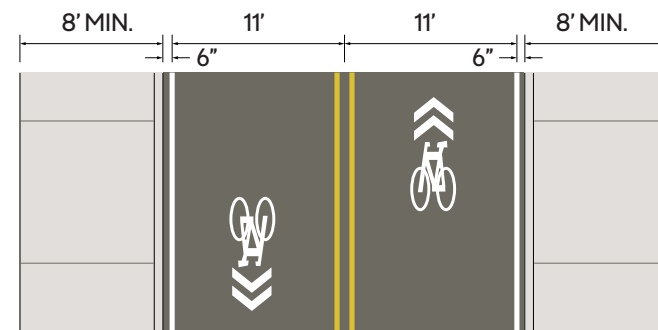

Where separate bike lanes are not achievable, provide markings and signage for shared bike lanes in the center of the travel lane.

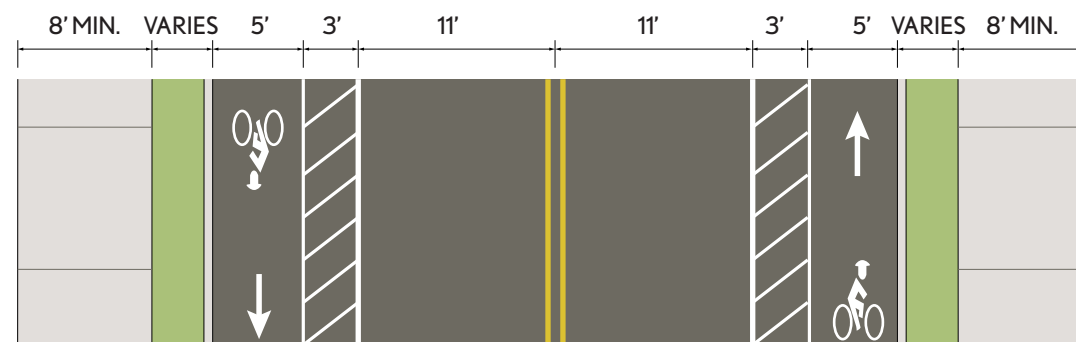

On streets with larger right-of-ways, sidewalks may be moved away from curbs to provide additional buffer between traffic types. The landscaped verge may be used for stormwater management or planted to deter mid-block pedestrian crossings. Examples include Highland Road and Dalrymple Drive.

PEDESTRIAN EXPERIENCE



Where space is limited, use flex posts, curbs, and site furnishings to provide separation between vehicles and pedestrians. New construction should include bike parking and new trees to provide shade where there is no existing canopy.



Some road conditions, such as along Highland Road or Nicholson Drive, are not appropriate for shared bike lanes. Consider moving pedestrian pathways to the outside of Live Oak trees, and reusing the existing sidewalks for elevated bike lanes.



Broad right-of-ways, such as along Skip Bertman Drive, include enough space for multiple configurations of bike lanes and sidewalks. Consider which options to use to create the most consistent, predictable experience for pedestrians and drivers.

3.1 CIRCULATION

CROSSWALKS & CURB RAMPS

DESIGN RATIONALE

Crosswalks and curb cuts serve to mediate between pedestrian and vehicular circulation systems. Safety on campus is greatly improved by providing clear, accessible opportunities for pedestrians to cross streets.

Emphasize pedestrian crossing locations on campus by using contrasting paving materials, high visibility paving, and providing a visual separation between roadway and crosswalks. Dark red brick paving, rated for vehicular traffic, is the standard paving material in crosswalks. Crosswalks should be elevated to create a “table” condition wherever possible. The sides of this table should be concrete paving for durability and contrast. These raised surfaces also slow down vehicular traffic and ensure the roadway will be dry for pedestrians crossing the road. Proper drainage is required at all raised crosswalks to avoid impeding roadway runoff. At mid-block crossings, a double-sided “STOP FOR PEDESTRIANS IN CROSSWALK” sign shall be surface mounted on a flexible base.

Curb ramps must be installed at all road crossings to provide an accessible means of crossing. Curb ramps shall meet all applicable ADA requirements including tactile warnings, pavement slopes, and appropriate signage and signaling.

Where curb ramps are adjacent to raised crosswalks, the two components should “split the difference” in grade change. This prevents storm water from pooling at the base of curb ramps and allows the curb & gutter system to effectively direct water to drains.

Where possible, curb ramp and crosswalk widths should match or even exceed the width of adjacent or intersecting pedestrian paths. This ensures adequate room is provided for pedestrian circulation in high foot-traffic areas.

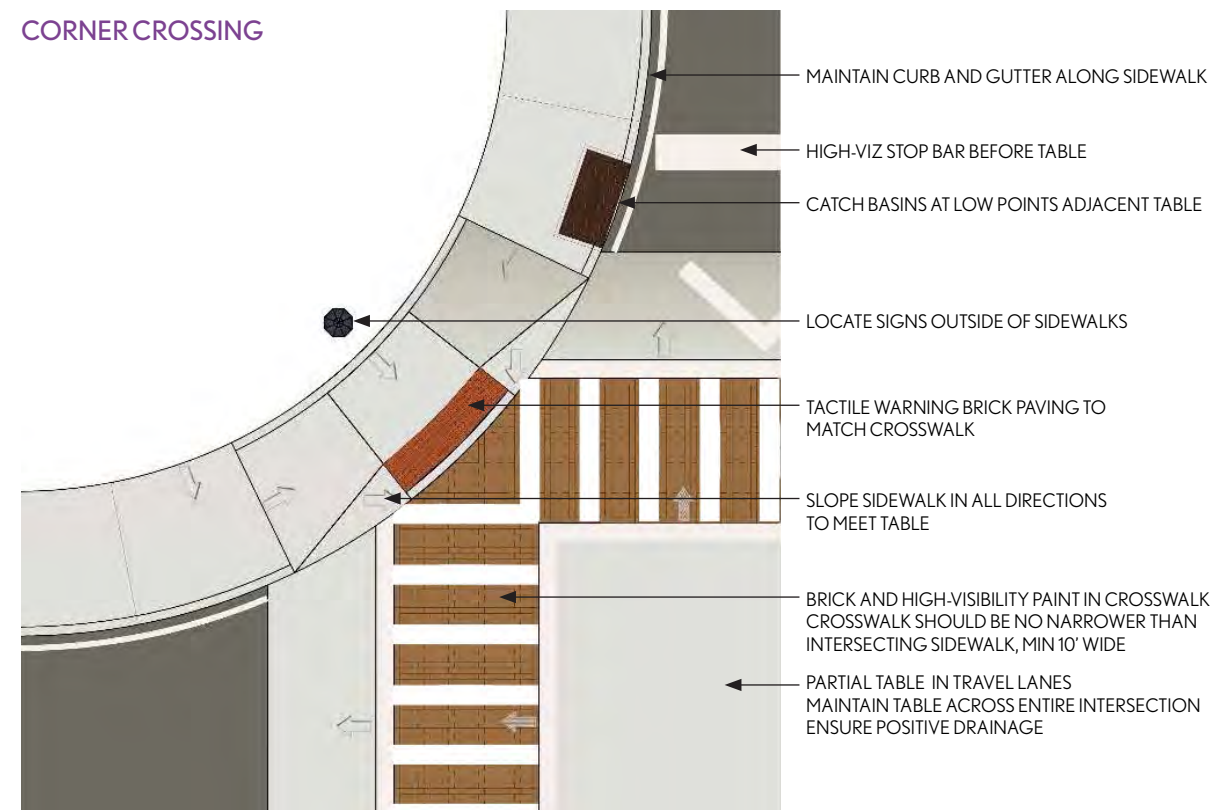
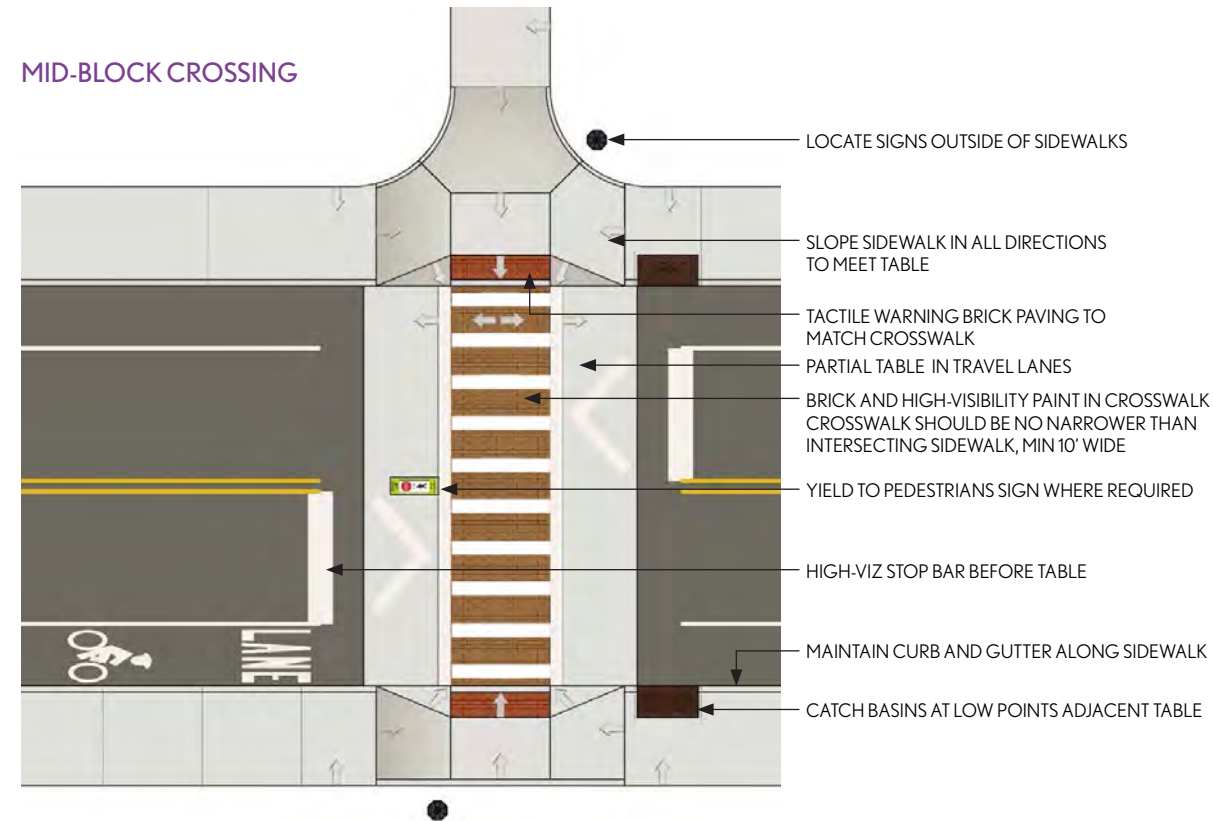

- ✓ Table and curb ramps prevent pooling water
- ✗ Paint is faded and not enough contrast



- ✗ Crosswalk without table allows water and debris to pool at curb
- ✗ Crosswalk width not consistent with entry paving width



- ✗ Crosswalk without table allows water and debris to pool at curb
- ✗ No landing area for the ramp



3.1 CIRCULATION PATHWAYS

DESIGN RATIONALE

Pathways form the connective tissue of the LSU campus, providing a safe and accessible means for pedestrians to move throughout the campus and between buildings and other destinations. Composed of a broad array of widths, materials, and usage types, the path network provides the fundamental means of clear wayfinding and circulation on the campus.

Designers should understand the programmatic needs of pathways in their project, as well as the existing path network extending beyond the project site, to ensure that new work provides the necessary capacity for pedestrians while maintaining a consistent path hierarchy and material language. Seamlessly blend paving into the existing network, and avoid creating discreet details or designs of paths that delineate projects. The design for all new hardscape on campus should strive to minimize, as much as possible, the amount of paved surfaces necessary for the project. Pathways represent a system that extends across the entire campus, and should not extend motifs or materials from buildings into the larger campus landscape.

Pathways should generally fit into one of the six types illustrated here, recognizing that the specific goals and context of a project will inform the pathway design. Appropriate materials must be selected from the Standards Catalog. Review the proposed materials, path widths, and connections with LSU.

All pathways should meet ADA standards for universal accessibility.

PATH HIERARCHY

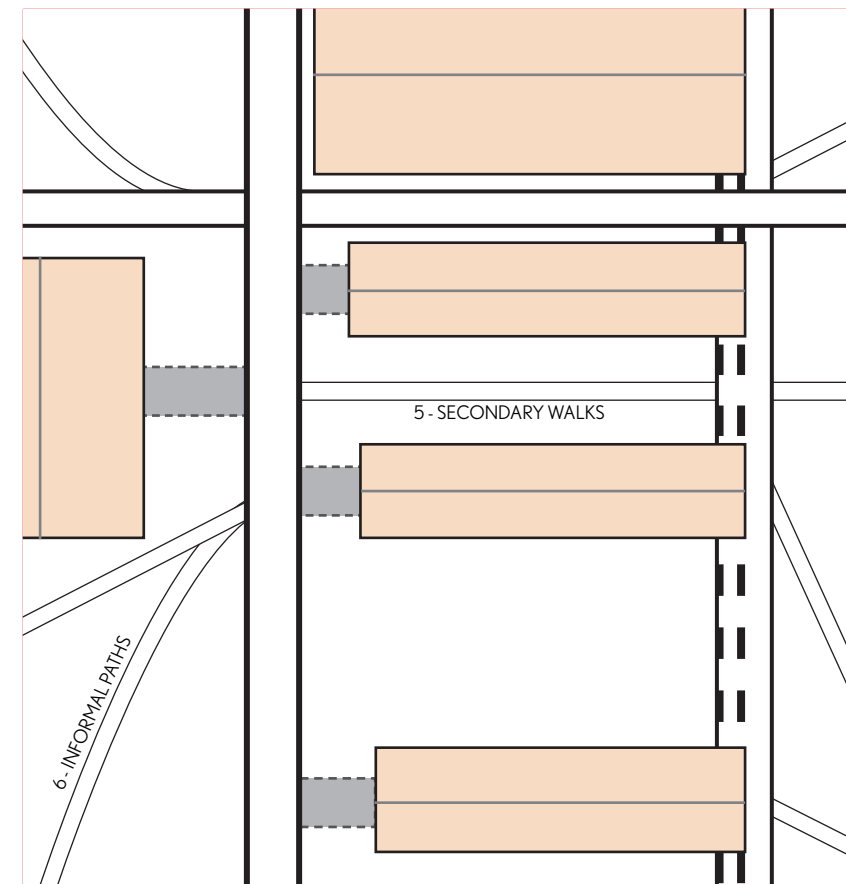

This diagram illustrates the relationships and hierarchies between different types of pathways and other paving elements. The descriptions to the right are general; the context and specific needs of a project must be considered.

1 - SPECIAL PAVING

continuous pedestrian paving promenade, uninterrupted by other paths or roadways
 MATERIAL: unit pavers for primary spaces
 WIDTH: 20' - 24', wider in areas with heavy bike traffic

2 - PRIMARY WALKS

continuous pedestrian paving spine, interrupted only by special paving or crosswalks
 MATERIAL: unit pavers for secondary spaces or concrete
 WIDTH: 12' - 16', wider in areas with heavy bike traffic

3 - COVERED WALKS

paving associated with circulation along quad and green edges, integral to building colonnade
 MATERIAL: unit pavers for secondary spaces or concrete
 WIDTH: colonnade width plus 8' minimum where extended

4 - BUILDING ENTRIES

paving extending from primary building doorways and including gathering spaces along the edges
 MATERIAL: unit pavers or concrete for primary or secondary spaces
 WIDTH: no less than building door width

5 - SECONDARY WALKS

intermediate paths connecting between other paths or destinations
 MATERIAL: concrete or permeable unit paving at trees
 WIDTH: 8' minimum, 12' maximum

6 - INFORMAL PATHS

trails or paths through natural spaces and greens
 MATERIAL: concrete, asphalt, or granular paving
 WIDTH: 6' - 8' (if wider, consider it a secondary walk)

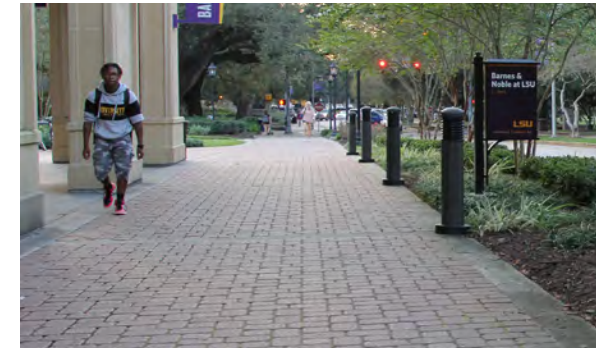

Covered walk with unit pavers



Primary walk with concrete paving

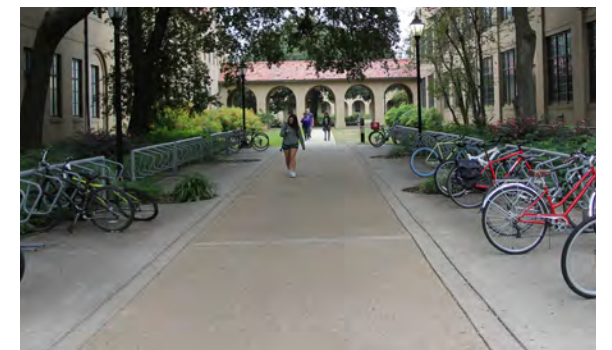

Secondary walk with concrete paving



Secondary walk with concrete paving



3.1 CIRCULATION

PAVING - CONCRETE

DESIGN RATIONALE

Cast-in-place concrete is the primary paving material for pathways and sidewalks throughout campus. Concrete paving can be installed by most site contractors and is resilient to high volumes of foot and vehicular traffic. The light color of concrete paving increases its solar reflectivity, reducing heat island effects typical of large paved areas. Concrete paving can be cut and patched with minimal difference in appearance when required for utility work.

Widths for concrete sidewalks and paths vary depending on the use and expected traffic volume. The minimum width for all walks shall be 8' unless specifically approved by LSU. Large expanses of uninterrupted concrete paving should be avoided to minimize impervious surfaces and to maintain an appropriate scale of landscape features. A light broom finish, perpendicular to the path of travel, provides a slip-resistant surface. The use of integrally colored, stained, or exposed aggregate concrete is discouraged, as other surface materials are more appropriate for creating contrast in paving surfaces and patching specialty concrete is difficult. Stamped and sealed concrete is not to be used.

Attention should be paid to the thickness and reinforcement of concrete paving in pedestrian areas and in areas that are subject to vehicular traffic. All concrete walks are to have a minimum thickness of 5.5". Areas of paving to receive vehicular traffic should be upsized appropriately to meet the load rating of the vehicles anticipated. See adjacent table for minimum thicknesses. Final paving profiles should be determined by civil or structural engineer. Properly spaced expansion and control joints help to reduce unwanted cracking during extreme temperatures. Avoid window-pane tooling at edges of paving. The design and patterning of concrete joints is an element of the composition of paving systems and reinforces circulation hierarchy. Joint layout should be included in construction documents by the landscape architect.

EXAMPLE DETAILS

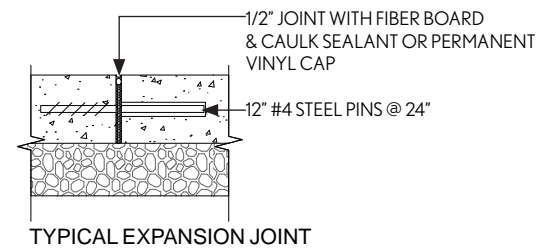
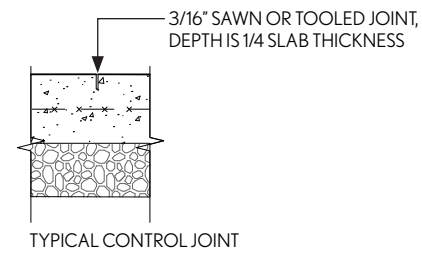
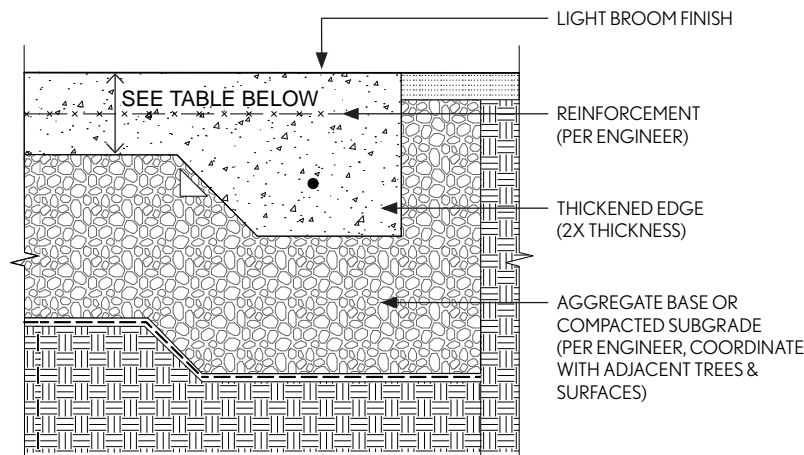

MINIMUM CONCRETE THICKNESSES

Bus stops:	7"
Dumpster pads:	8"
Parking spaces:	6"
Parking drives:	7"
Sidewalks	5.5"

CROSS INTERSECTIONS

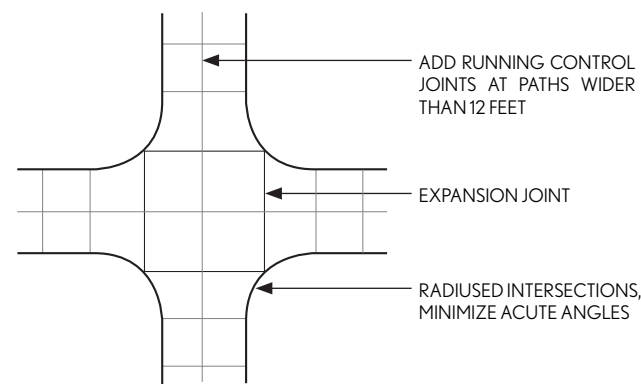

T-INTERSECTIONS

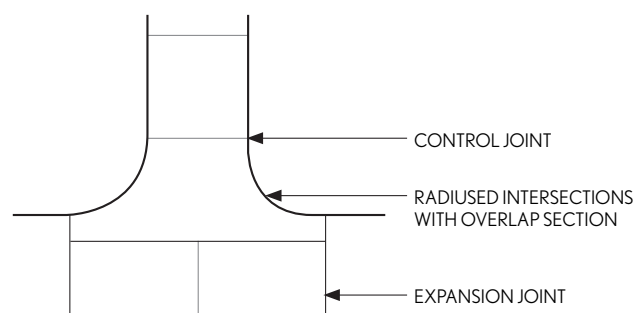

PATH JOINT SPACING

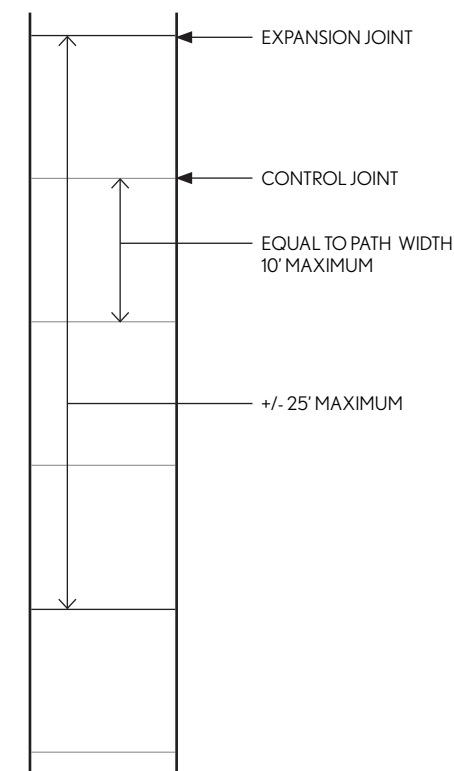

Concrete paving used at building entry plaza



Combined vehicular and pedestrian concrete paving

Typical concrete pedestrian path

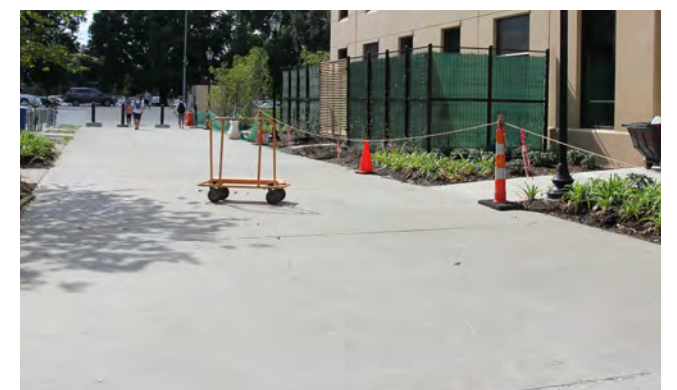

Concrete paving at major pedestrian pathway



3.1 CIRCULATION

PAVING - UNIT PAVERS

DESIGN RATIONALE

Unit paving is used in a variety of applications across the campus. Providing a visual contrast to other monolithic paving materials, unit pavers can be used to demarcate prominent spaces or paths of interest, to break down the scale of large paved areas, and to improve stormwater management through the use of permeable paving systems. Relative to other paving materials, unit pavers are easier to remove and replace when sub-surface work is required. See Chapter 2 of this document for locations where unit pavers are commonly used.

Pavers are typically installed with a cast-in-place concrete restraint edge band. The width of the band should be coordinated with the paver size and pattern, but shall be no smaller than 4" wide. Where possible, provide a cast concrete path wide enough for small scooters to move through or along unit paver areas. Pavers in pedestrian or permeable areas are typically installed over a compacted aggregate base. In vehicular areas, ensure that the paver thickness and base courses are appropriately sized and design for the type of loading anticipated. Joints are to be filled with non-cementitious fine aggregate materials to allow individual units to move under loads without cracking.

The detailing of paver surfaces should be coordinated with a civil or structural engineer with input from the geotechnical engineer. The details shown here are for reference only.

EXAMPLE DETAIL: STANDARD INSTALLATION

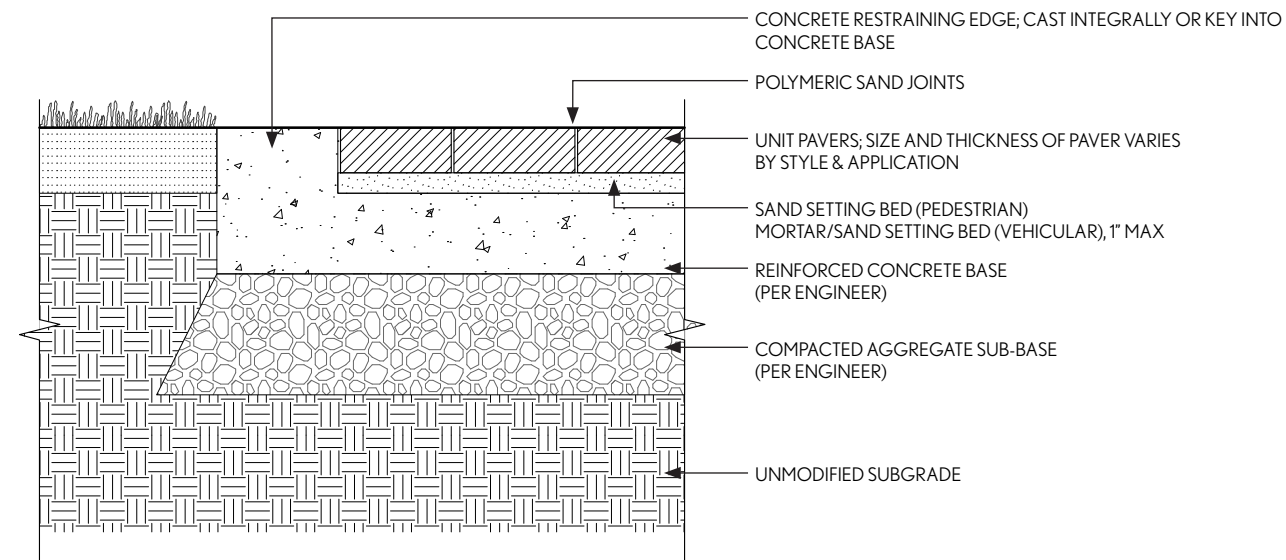

EXAMPLE DETAIL: PERMEABLE INSTALLATION

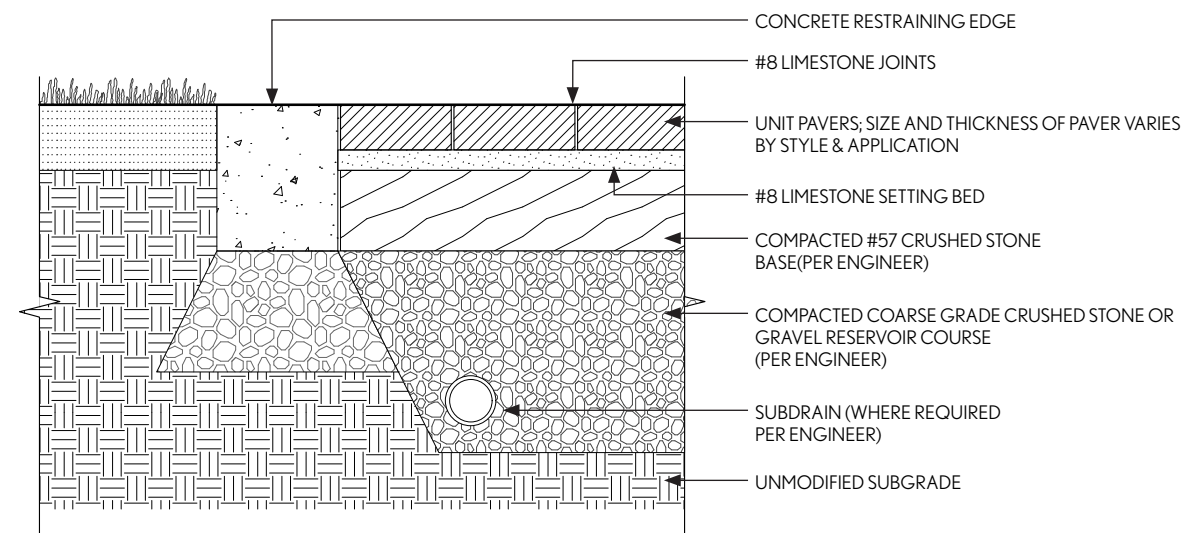

Pavers used to distinguish a seating area



A variety of concrete paver types and colors in a plaza



Permeable paving at parking areas

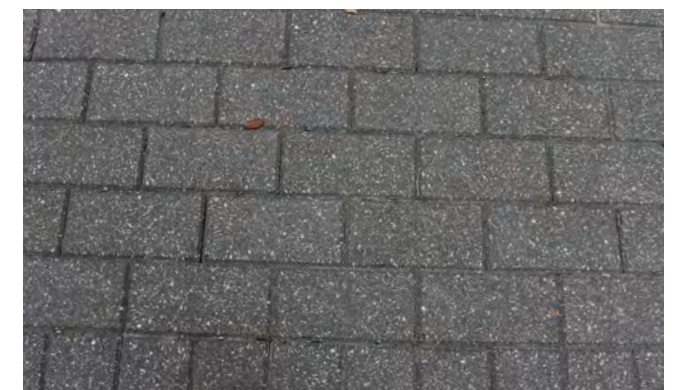

Gray permeable pavers used in a sidewalk

PAVER MATRIX

Concrete pavers in a blend of warm colors, similar to the terra cotta tile roof colors found on historic buildings on campus, are the campus standard. Gray pavers are used for sidewalk or parking applications near the root zone for trees. At building entry paving, paver color blends may be modified to coordinate with building materials with approval from LSU.

Pavers may be arranged in different patterns depending on the paver model selected. Contemporary patterns of gauged width and running bonds are best for pathway, promenade, rectilinear plazas, and areas likely to receive vehicular traffic, and should be aligned with the continuous joints aligned perpendicular to the path of travel. Classic patterns such as tudor or herringbone are best used in non-directional applications such as small plazas, courtyards, or accents. Stack bonds are discouraged due to potential for uneven settlement and misalignment of paver surfaces.

Many paver manufacturers offer options for the finish of edges on individual units. Square edge pavers are preferred, and slight bevel or radius edges are acceptable. Pavers with significant bevels or radii should be avoided as these types of edges create accessibility issues for wheelchairs and other mobility devices. Specify spacer lugs on pavers to be held down from the top surface of pavers so they are not visible in the finished application. All pavers used in vehicular areas must be traffic-rated to the appropriate type of vehicular use.

While used in several locations, pavers with a beveled edge should not be applied in new installations and are only to be used in areas adjacent or relating to existing installations.

PRIMARY SPACES

STANDARD PAVING

Rectangular permeable or non-permeable (preferred)



NAME: Eco-priora paver blend (standard or permeable)
 PATTERN: 90° Herringbone & Running Bond
 JOINTS: Polymeric sand (standard)
 #8 Limestone (permeable)
 COLOR: 53% Autumn Blend; 34% Terra Cotta; 13% Austin Blend

CLASSIC PAVING

Rectangular permeable or non-permeable (alternate)



NAME: The Pavestone 'Plaza Stone Rectangle & Square Blend' (non-permeable)
 PATTERN: Alternating / Tudor
 JOINTS: Polymeric sand
 COLOR: 43% Autumn (Rectangles); 14% Terra Cotta (Rectangles); 10% Austin Blend (Squares); 13% Terra Cotta (Squares); 13% Austin Stone Blend (Squares)

SECONDARY SPACES

SIDEWALK PAVING

Rectangular permeable or non-permeable (preferred)



NAME: Pavestone Eco-Enviro Stone
 PATTERN: Running bond
 JOINTS: #8 decomposed granite or limestone
 COLOR: Warm gray range

CONTEMPORARY PAVING

Elongated "boardwalk" paver (alternate)

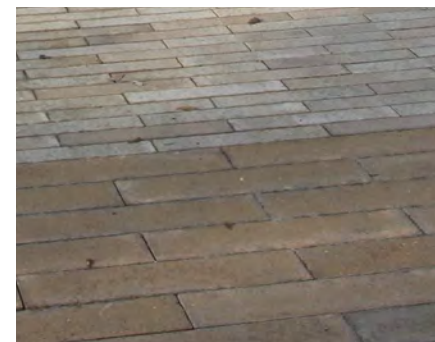

NAME: Pavestone Verona
 PATTERN: Running bond
 JOINTS: Polymeric sand
 COLOR: Warm Grays and Tans

CROSSWALKS & CURB CUTS

CROSSWALK PAVING

Rectangular concrete or asphalt pavers (preferred)



NAME: Clay or concrete units
 PATTERN: Running Bond
 JOINTS: Polymeric sand
 COLOR: Red
 NOTE: Pavers in vehicular areas must be traffic-rated

TACTILE WARNING STRIP

Rectangular truncated dome pavers (preferred)



NAME: Handicap Ramp Truncated Dome Pavers
 PATTERN: Running Bond
 RECTANGLE: 3-7/8 W x 7-13/16 L x 2-3/8 T
 JOINTS: Polymeric sand
 BASE: 1" mortar bed (1:7 cement sand) on 6" concrete
 COLOR: Red
 NOTE: Pavers in vehicular areas must be traffic-rated

3.1 CIRCULATION

PAVING - ASPHALT

DESIGN RATIONALE

Asphalt paving is primarily used on vehicular and utility surfaces throughout campus. Its use for pedestrian applications is only allowed as a temporary surface or for trails with LSU permission. In these instances, it should be detailed to ensure that the surface or subbase do not fail and that it drains properly. Where possible, use asphalt that is tinted a lighter color to reduce heat island effects.

Permeable asphalt is encouraged to be used as a tool for managing storm water. For permeable asphalt to be effective in the heavy clay and silt soils of campus, a significant gravel reservoir and overflow pipe is recommended. The reservoir allows storm water to be held while it slowly infiltrates into the adjacent soils and back to the water table. Potential locations for permeable asphalt should be reviewed and coordinated with LSU.

The profile and detailing for asphalt roadway and parking lots should be provided by a civil or structural engineer with input from the geotechnical engineer. The details shown here are for reference only.

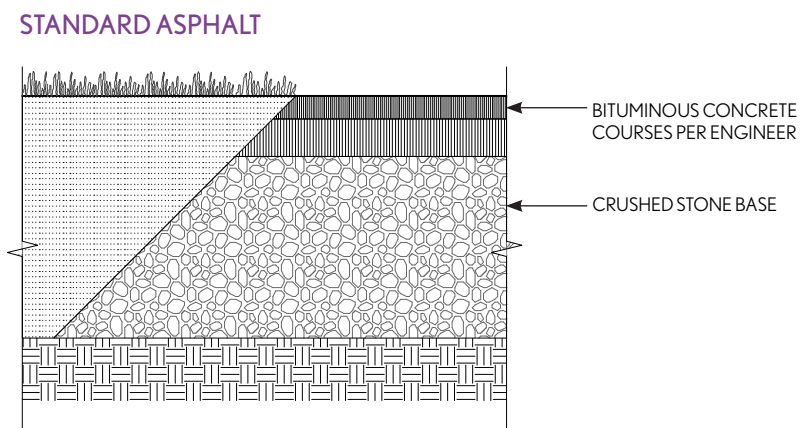
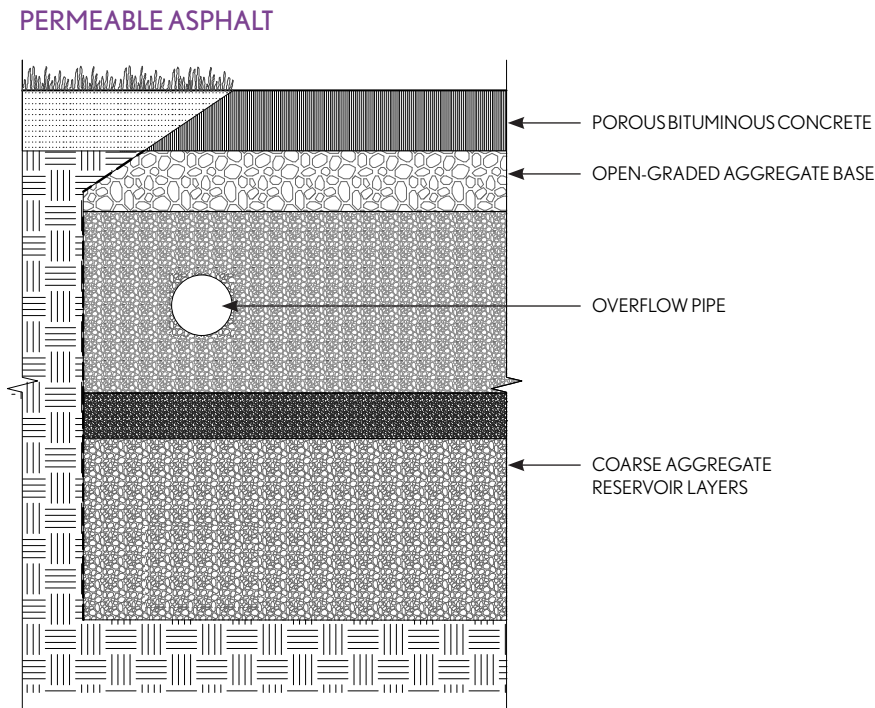

NOTE: Thickness of bituminous courses and sub-bases vary depending on application. All dimensions should be coordinated with the Civil and Geotechnical engineers for a project, including the design and locations for curb and gutter edge details.



Typical asphalt roadway application on campus



Examples of asphalt used as pedestrian path or trail



Examples of permeable asphalt in parking lot applications



3.1 CIRCULATION

PAVING - GRANULAR STONE

DESIGN RATIONALE

Granular paving provides a flexible paving alternative at a relatively low cost. Most granular paving surfaces are permeable, allowing the highest rate of stormwater infiltration among common paving materials. Granular paving is especially useful in areas where paving around tree roots is desired, as the material can be placed against the tree trunk and roots with minimal effort and without harming the tree.

Granular stone surfaces include crushed limestone, decomposed granite, and pea gravel. Use these materials in the appropriate application to make the most of their attributes. Crushed limestone (commonly graded as #57 stone, 3/4" size) is often used in temporary parking and utility area applications. Its angular shape allows it to compact into a hard-packed surface. Decomposed granite is often used in pedestrian paving applications. Often referred to as stone dust paving, it is commonly graded as a blend of 3/8" and smaller pieces. The inclusion of "fines" allow it to compact into a smooth surface, and the addition of a chemical binder prevents the surface from loosening under pressure. Decomposed granite surfaces with binders typically qualify as accessible by ADA standards.

Use warm colors of granular paving to correspond to the tan and orange tones of the campus architecture.

Edging is required to maintain the durability and installation of granular paving surfaces. Edging may be either metal edging staked into place or a concrete border strip or curb, similar to unit paving.

A chemical binder is recommended for granular paving. Binders are blended with dry paving materials before placement, then saturated with water to activate the chemical adhesion. Binders are safe for use around planted areas, and allow the paving to remain permeable.

Avoid using granular paving materials on sloped surfaces or walks greater than 3%, as these areas are likely to develop ruts and erosion in the paving surface.

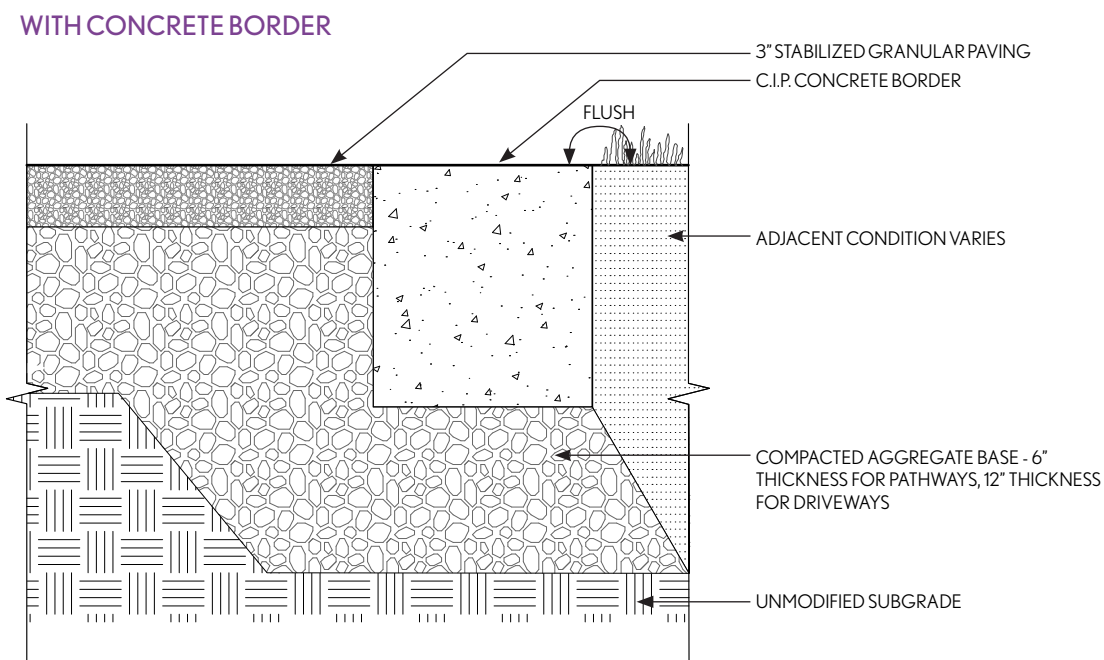
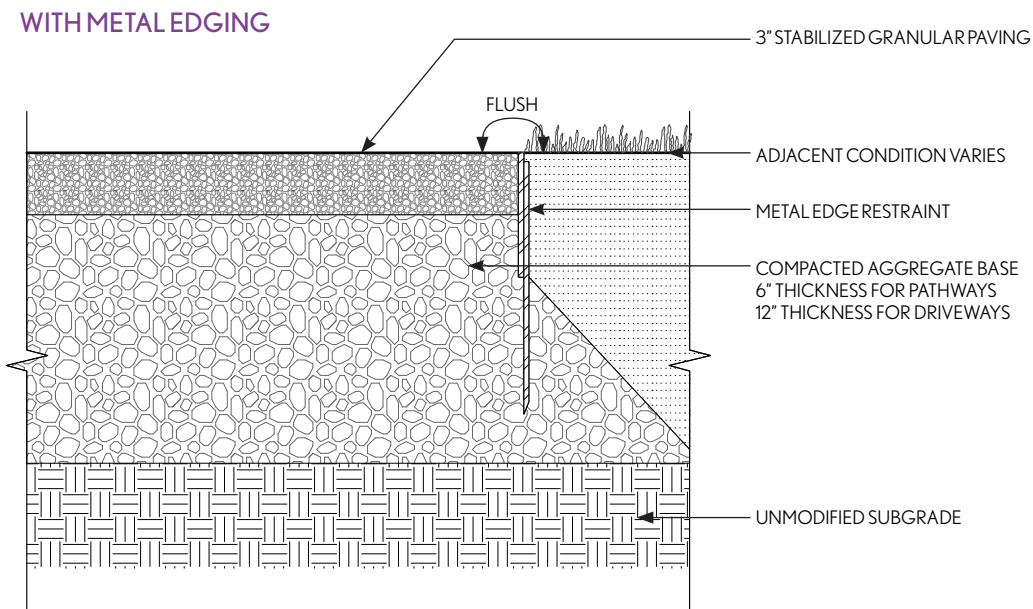

Crushed limestone as a vehicular paving surface



Decomposed granite paving around trees



Stone dust in a large paved area

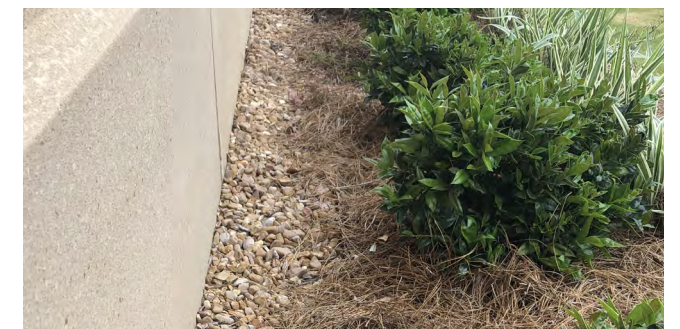

Large-grade gravel used as a drainage/maintenance strip



3.2 FURNISHING BENCHES

DESIGN RATIONALE

Benches are the primary seating component on campus. Many styles and designs of benches have been used on campus throughout its history. The campus standard bench with a back is a simple metal-strap bench that is durable and provides a comfortable seating experience. The character of the bench is complementary to other standard site components.

Some spaces require more opportunities for seating than a typical backed-bench allows. In these spaces, a backless bench may be used. The backless bench allows for seating in several positions, including facing in all directions, or straddling the bench and using it as a table. While the backed bench is a standard style that should be used in public spaces across campus, the backless bench offers more flexibility in material and design character. All alternative bench styles must be approved by LSU.

Regardless of location or style, benches should be configured to encourage social interaction and group gathering. Some conditions will require backed benches to be lined along a path or gathering space, however every opportunity should be taken to arrange benches in a forward facing configuration. See the diagrams on the opposite page for examples.

Avoid placing benches in or on the primary travel route. Instead, locate them on paved pads adjacent to these circulation elements. With backless benches, ensure the paved pad is large enough to allow movement around all sides of the bench.

BACKED BENCH

Metal bench with horizontal slats and gently curved forms



LENGTH: 72"

COLOR: Gloss black powder coat

INSTALLATION: at concrete:

- surface mount at pavers
- surface mount to base slab



RECOMMENDED MANUFACTURED MODELS:

- Victor Stanley RBF-28, 6' Ribbon Bench (preferred)
- Landscape Forms Scarborough 72" Backed Horizontal
- Keystone Ridge Designs - P26 6' Pullman

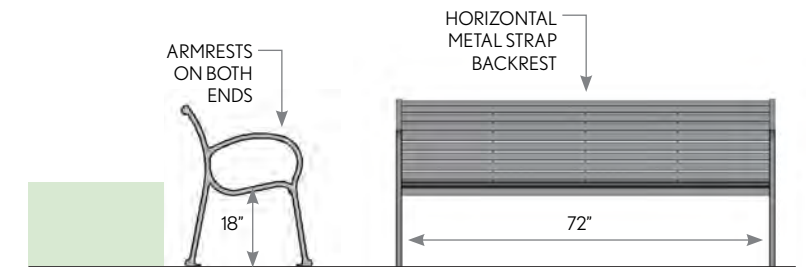

BACKLESS BENCH

Monolithic or slab bench with simple form and material



LENGTH: 72"-117"

COLOR: White or Gray precast concrete

INSTALLATION: at concrete:

- surface mount at pavers
- surface mount to base slab



Note: The form of this bench is desirable in historic areas, however exposed aggregate should be avoided. See dimensions in adjacent sketch for replication purposes.

MONOLITHIC BENCH GENERAL SIZING

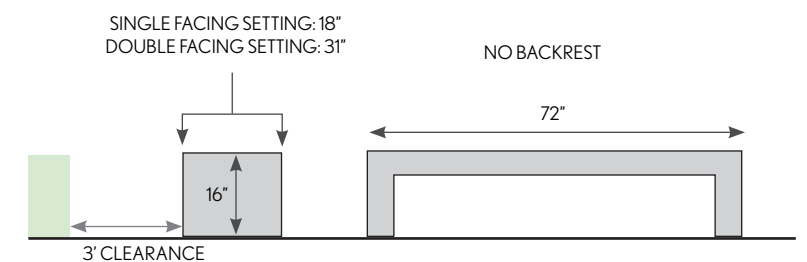

HISTORIC BENCH DIMENSIONS

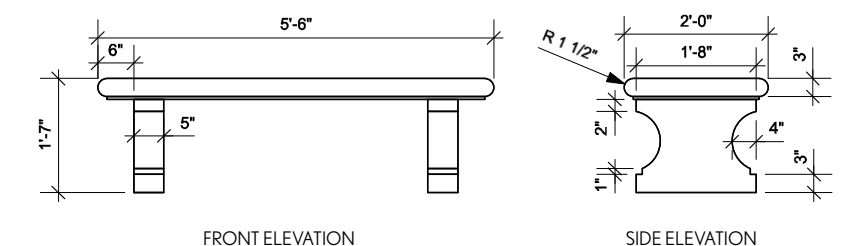

BACKED BENCH CONFIGURATIONS

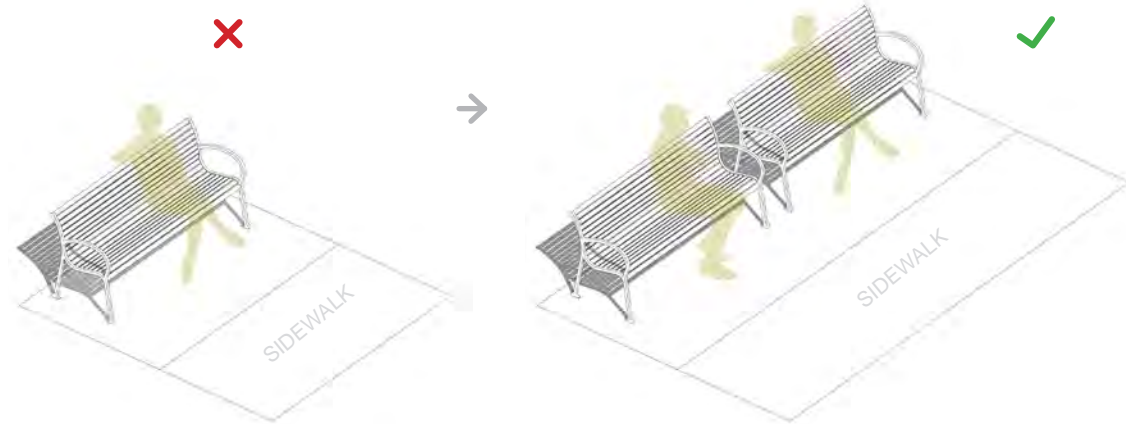

Locate benches in pairs for more seating capacity

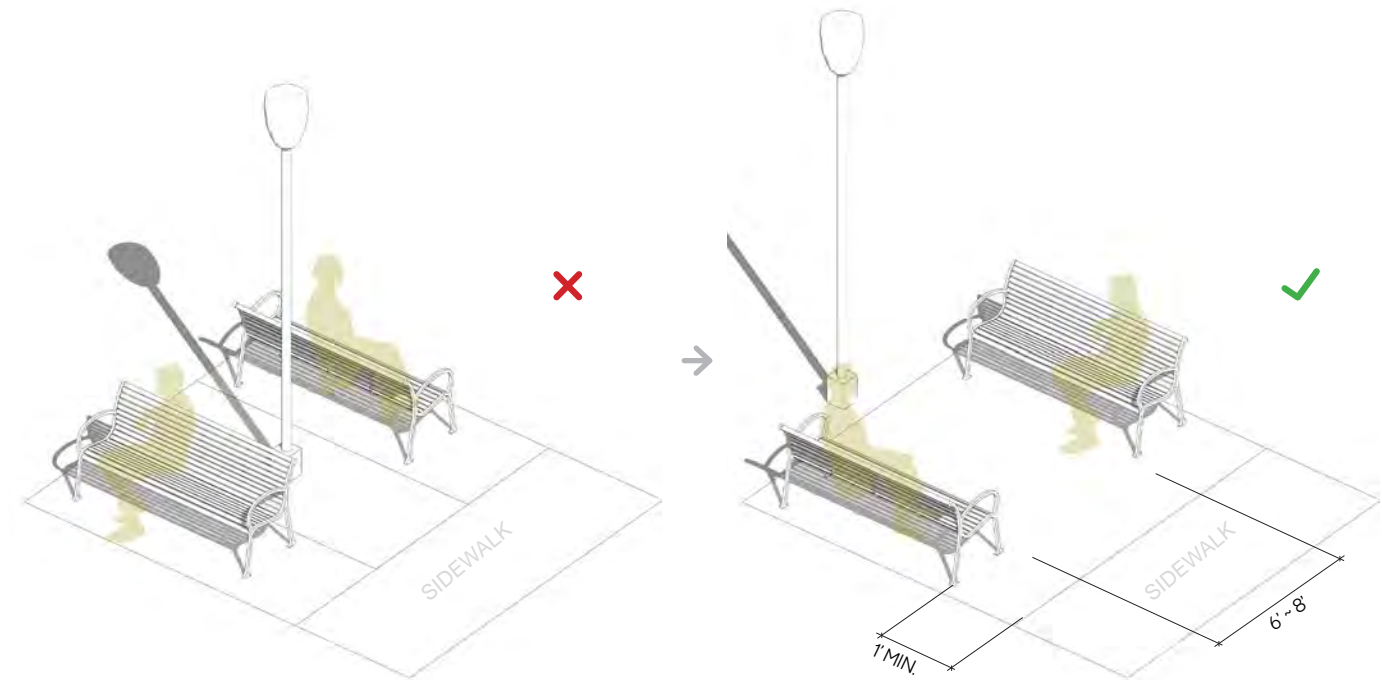

Benches should face inwards for more social engagement

BACKLESS BENCH CONFIGURATIONS

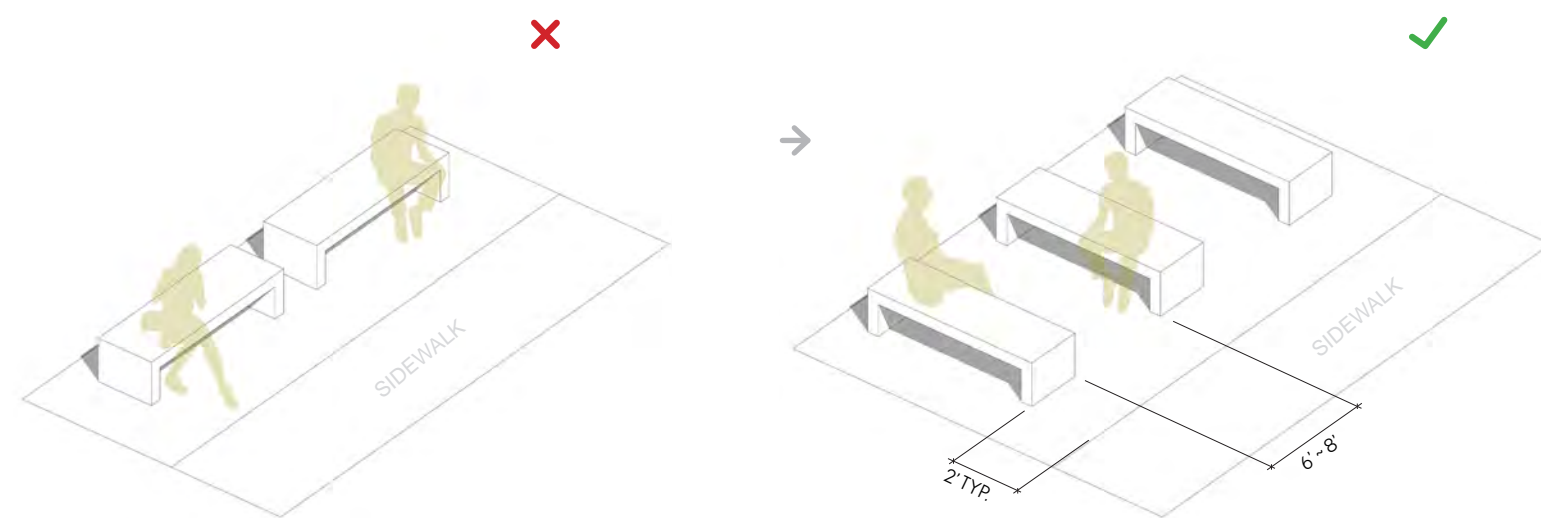

Create gathering and social spaces with groups of benches



While these benches at the UREC are properly positioned outside of the circulation path, their back-to-back configuration discourages social interaction.



3.2 FURNISHING

PICNIC TABLES & MOVABLE FURNITURE

DESIGN RATIONALE

While benches are the primary seating component on campus, other forms of seating can create interesting opportunities to gather and interact.

Picnic tables provide both seating and a surface for studying, eating, or other group activities that require a shared surface. Picnic tables should be thoughtfully located to take advantage of shade, as their surfaces often get hot in direct sun. The character of picnic tables should be similar to that of benches and trash receptacles to maintain a consistent family of furnishings. Also take into consideration the geometries and character of the adjacent landscape and architecture when deciding between round or rectangular picnic tables.

Café tables & chairs offer similar opportunities to picnic tables, but are more flexible in their application because they can be moved and configured to suit changing demands on campus spaces. Use models that are stable on a variety of surfaces and are heavy enough to discourage theft or defacing.

Many other types of chairs are available that can be used to enliven outdoor spaces, particularly in residential areas. Adirondack chairs are an example of a comfortable seat with wide arms for resting books, laptops, or snacks. The chairs can be moved easily for sitting in groups or in private. Creatively employing colored materials can brighten spaces and create a sense of branding and community.

Moveable tables, chairs, and other seating types are recommended for use only in enclosed, controllable spaces, and with LSU approval.

PICNIC TABLE 1

Round steel solid table set with curved strap benches and ADA accessibility

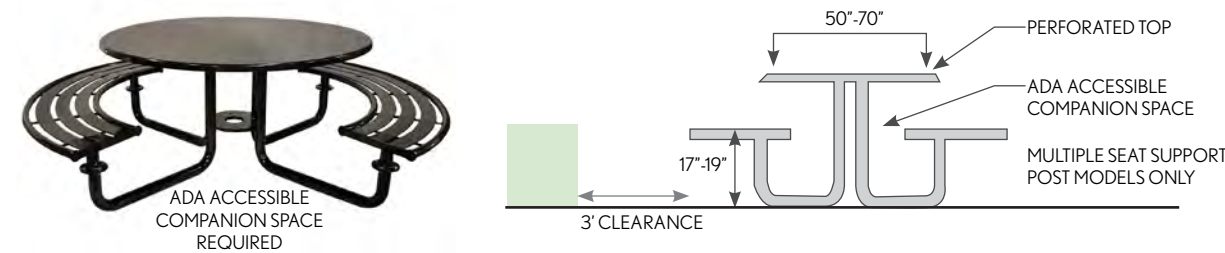

SIZE: 50-70" diameter

COLOR: Matte black powder coat

INSTALLATION: place on paved surfaces, surface mount where required. No embedded models

NOTE: Umbrellas may be incorporated into picnic tables at residential areas and courtyards. Wood and composite models are not allowed

RECOMMENDED MANUFACTURER & MODELS:

- Keystone Ridge PN6CU Penn Table with Curved Seats
- Landscape Forms Charlie
- Victor Stanley Steelsites Collection RND 363

PICNIC TABLE 2

Rectangular table and accompanying benches with metal frame and recycled plastic slats



LENGTH: 96" table w/ 72" seats

COLOR: black powdercoat & gray slats

INSTALLATION: Surface mount only, on level paved surfaces. Ensure bench lengths allow ADA access

RECOMMENDED MANUFACTURER & MODELS:

- Victor Stanley CM-565
- Forms+Surfaces Knight Table

CAFE TABLE & CHAIRS

Heavy duty movable furniture for use in courtyards, outdoor dining areas, plazas, and other controlled spaces



Use chairs with bottom bars on soft surfaces such as lawn or decomposed granite paving. Chairs with post feet may be used on concrete and unit paver surfaces



RECOMMENDED MANUFACTURER & MODELS:

- Landscape Forms Parc Centre Chair & Table
- Landscape Forms Chipman Chair & Table

LAWN CHAIRS

Chair with various materials, shapes, and colors



RECOMMENDED MANUFACTURED MODELS:

- Design Within Reach Adirondack Chair
- Adirondack chair from other manufacturer

3.2 FURNISHING

LITTER RECEPTACLES

DESIGN RATIONALE

Appropriately locating trash and recycling receptacles is a critical part of maintaining a clean and beautiful campus landscape. The campus community generates thousands of pounds of waste each day that must be collected and removed from campus. By providing the right quantity of receptacles and locating them in the most likely places for trash to be disposed, the burden of picking up litter is greatly reduced.

Receptacles should be located adjacent to primary circulation pathways on a paved surface. They should be away from path intersections and outside of the primary walking surface to avoid conflicts with circulation. The locations for receptacles should also be reasonably accessible by grounds staff responsible for emptying the receptacles daily.

A metal strap-style receptacle is the campus standard. It is similar to the standard bench and other site components. A domed top prevents rain and leaves from falling into the receptacle, and a side door allows easier access for staff. When receptacles are located adjacent to garden or groundcover planting, provide sufficient space around the unit for emptying and cleaning. LSU is a smoke-free campus and trash receptacles should not include ash trays.

Recycling is a primary objective of the LSU community, and receptacles to collect recycling should be located next to all trash receptacles. Include decals or other integral signage to distinguish trash and recycling receptacles.

RECEPTACLE 1

Metal receptacle with vertical slats, raised dome top, and side door

- HEIGHT: 36" - 40"
- CAPACITY: 25-35 gallons
- COLOR: Black powder coat
- INSTALLATION: surface mounted

RECOMMENDED MANUFACTURER & MODELS:

- Victor Stanley SD-42-S-2A with raised dome top (preferred)
- Landscape Forms "Chase Park"

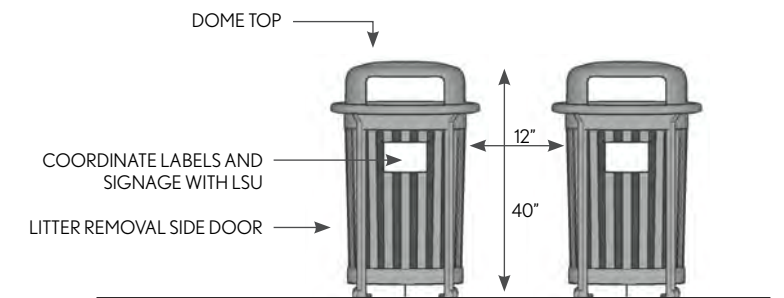

LITTER DISTRIBUTION BY TYPOLOGY

Different types of campus spaces are more prone to generate litter. The diagram below suggests an approximate breakdown of where receptacles should be distributed relative to the landscape typologies.



LANDSCAPE ELEMENTS & TRASH LOCATIONS

Locate receptacles and dumpsters with consideration for other landscape elements. Some landscape elements such as vegetation or screening can be used to mitigate the appearance of dumpsters.

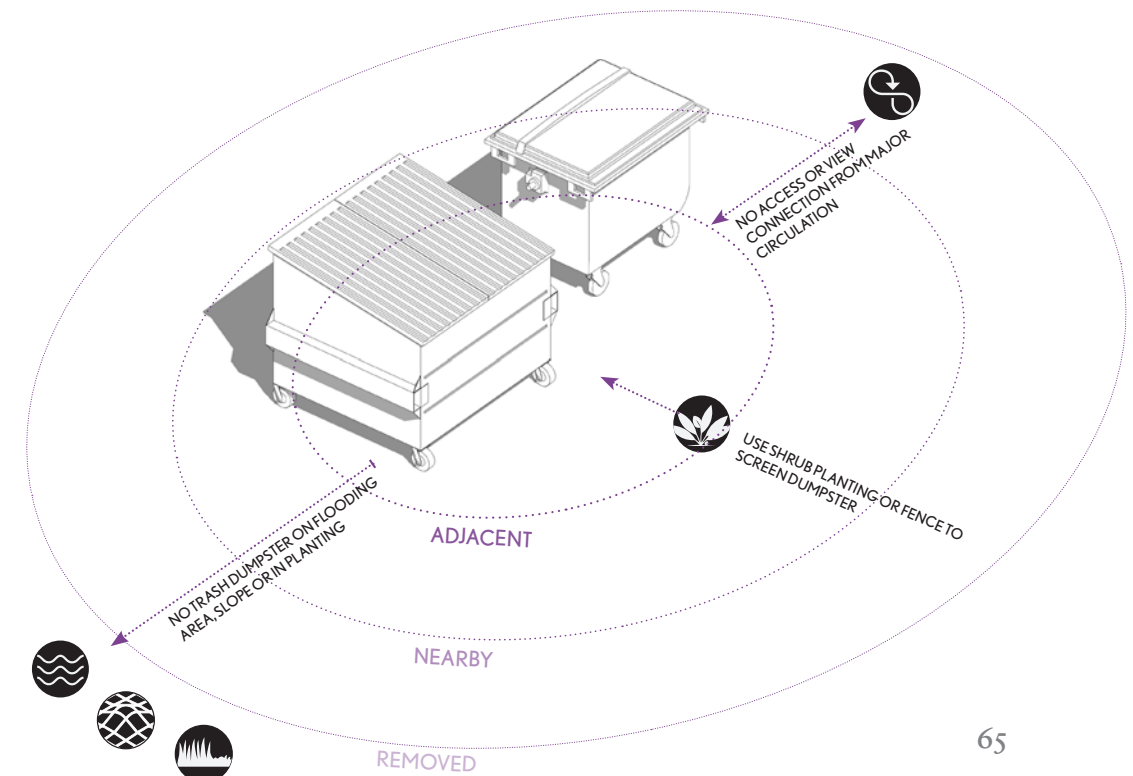
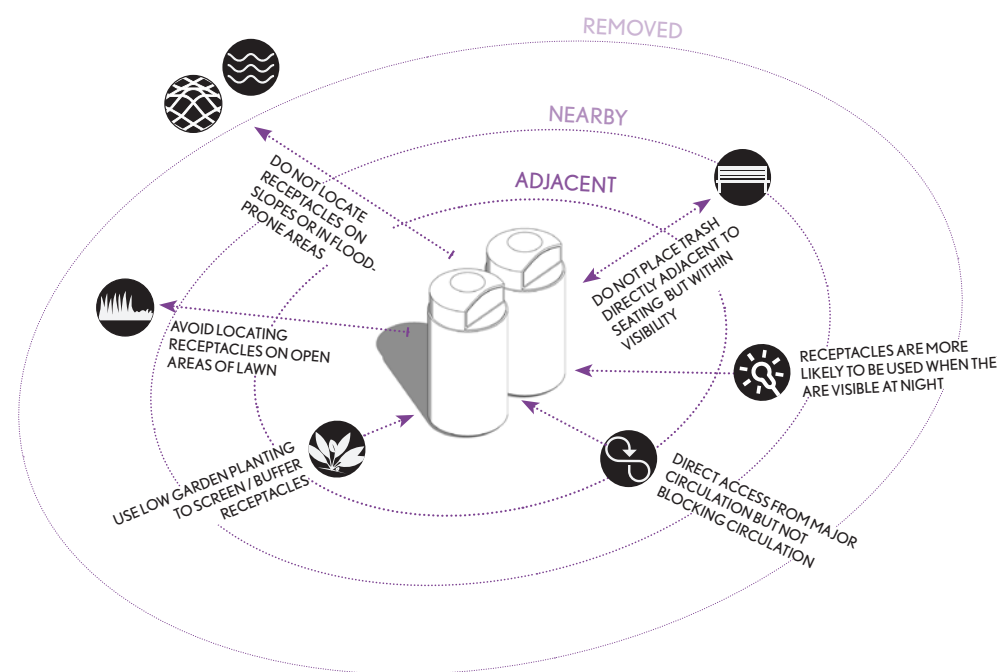



3.2 FURNISHING

BIKE RACKS

DESIGN RATIONALE

Bike racks are provided in various forms throughout the campus to accommodate an important mode of transportation and circulation. As biking and bicycle commuting are becoming more popular, the University has worked to provide sufficient parking areas in existing spaces and new projects. The standard bike rack, a corral-style single or double sided assembly, has proven to be a reliable and durable site component. Because it is surface-mounted, the standard rack provides flexibility for University staff to respond to growing and changing demand, as well as unforeseen conflicts between bike parking and other modes of circulation.

These aspects of bike parking should be taken into consideration during a landscape design process. Bike racks should be located on an appropriately paved, level surface, and should be screened by vegetation or other structures. Designers should work with the University to determine how many bike racks are necessary to support the demand of specific buildings and programs, and to anticipate growth in demand over time, so that modifying bike parking supply in the future fits within a predetermined system and design. Retrofit projects should carefully consider the spatial demands of bike parking to ensure conflicts are avoided. Provide direct access to bike paths from rack areas. Locate racks outside of dismount zones.

Some projects may necessitate the need for permanent or reduced-impact bike parking, and in these instances alternative bike racks may be proposed for use. The design and selection of alternative racks should be sensitive to adjacent architectural expression and must be reviewed and approved by LSU.

STANDARD BIKE RACK

Single- or double-sided, surface mount bike corral with a galvanized finish

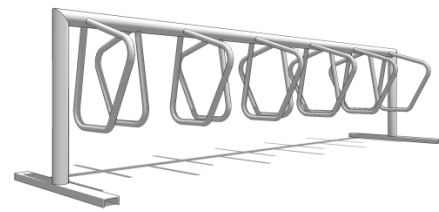

LENGTH: 114"

COLOR: Galvanized finish

INSTALLATION: surface mount;
embedment not allowed



RECOMMENDED MANUFACTURED MODELS:

- Dero Campus Rack D11 139" (preferred)
- Sportworks 'Plaza' High Density Bike Rack
- Forms & Surfaces 'Cordia Bike Rack' (configured to match Dero)
- Maglin MBR350-5-s

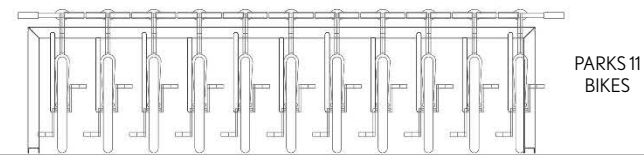

ALTERNATE BIKE RACKS

Embedded multi-directional bike rack with stainless steel or galvanized finish



HEIGHT: 30" - 36"

COLOR: stainless or galvanized

INSTALLATION: embedded

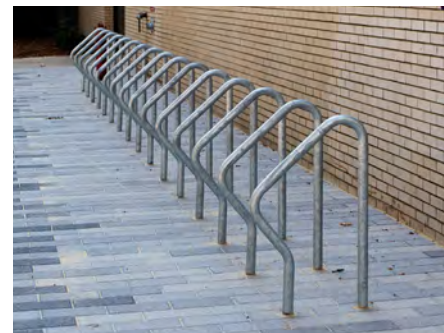

RECOMMENDED MANUFACTURED MODELS:

- Landscape Forms Loop Bike Rack (preferred)
- Landscapeforms Bicilinea Bike Rack

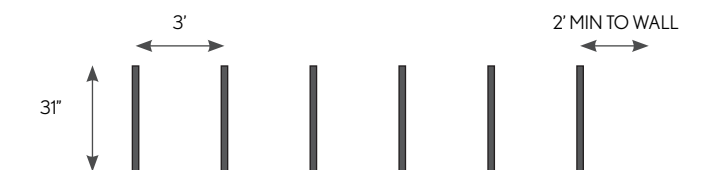

BIKE RACK SCREENING

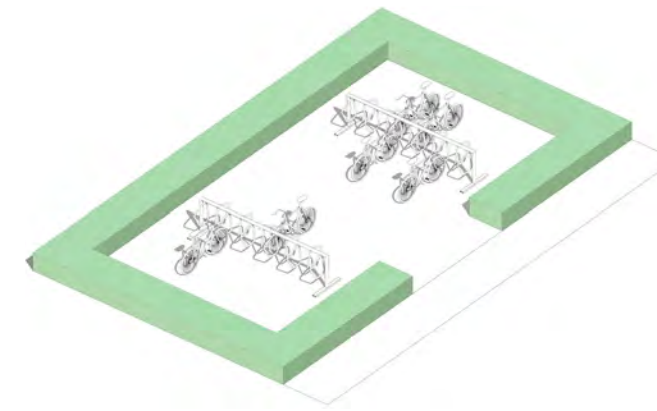

Bicycle racks and parking areas should be screened on 3 or more sides. Screening should favor important views and corridors where possible. Screening with low, evergreen shrubs and ornamental trees is recommended, though other groundcovers and small trees may be used as well. Ensure that sufficient access to and circulation through bike parking areas is provided.



Recent screened bike parking at Taylor Hall

BIKE RACK SHELTER

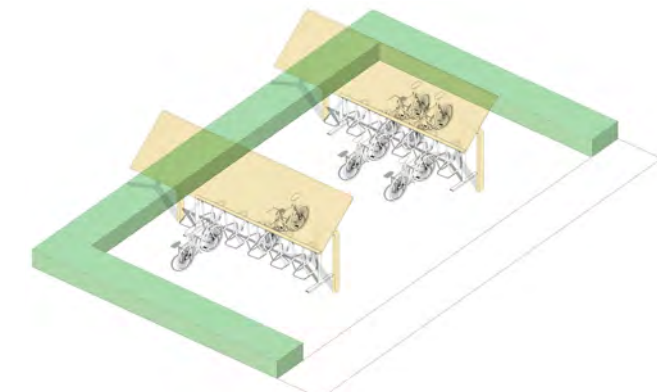

Covered bike racks offer additional protection from rain and scorching sun. Consider providing covered bike parking areas in all projects with sufficient space to accommodate the structure. Structure design should be sensitive to the architecture expression and character of adjacent buildings and landscapes. All structures are to be reviewed and approved by LSU.



Recent covered bike parking at Nicholson Gateway



3.2 FURNISHING BOLLARDS

DESIGN RATIONALE

Bollards are used throughout campus to control and regulate vehicular circulation. Bollards can provide different levels of deterrent and protection depending on the context and application. Generally, most bollards on campus are used to deter vehicles from entering spaces intended for pedestrians. These bollards function as a warning and physical barrier to prevent most drivers from entering spaces not intended for vehicles, however they are not designed to prevent or stop significant vehicle impacts. Where occasional vehicular access is required for service or fire lanes, these bollards may feature an embedded sleeve and lock assembly that allows them to be removed temporarily. They may feature simple ornamentation to provide consistency with the character and style of other site elements and architecture.

When physical prevention from impacts is required, utility-style bollards are to be used. Utility bollards are typically steel columns with reinforced concrete cores engineered to withstand the force of a vehicle. These bollards may feature the same ornamentation as deterrent bollards, but are typically larger and include bright elements for increased visibility, especially in service areas.

Pedestrian bollards provide a visual separation for both pedestrians and vehicles. Typically made of plastic and including a flexible rubber boot base, these bollards do not offer any kind of physical deterrent to vehicle or bicycle impacts. They will not prevent a determined driver from entering spaces not intended from vehicles. Their design allows for easy removal for seasonal or major event situations.

The use of horizontal steel rails, wooden bollards, concrete bollards, and other forms of vehicle deterrents is discouraged on campus.

VEHICULAR BOLLARDS

Ornamental metal bollards used to deter vehicular access to pedestrian areas



SIZE: 30" - 40" ht, 3"-4" diameter RECOMMENDED MANUFACTURER & MODELS:

COLOR: Black

- Traditional bollards by Street Furniture

INSTALLATION:

- surface mount or embedded
- removable as necessary

UTILITY BOLLARDS

Reinforced steel and concrete bollards used to protect against vehicle impacts



SIZE: 32" - 42" ht, 4" - 6" diameter

COLOR: Black with safety yellow reflective marking. Yellow or gray allowed in specific locations

INSTALLATION:

- embedded in concrete footing
- filled with reinforced concrete

PEDESTRIAN BOLLARDS

Flexible, easily removable bollards used to identify pedestrian-only zones & bike lanes

SIZE: 30" - 36" ht, 2.5" - 3.5" dia.

COLOR: Yellow or white with matching reflective bands at top

INSTALLATION:

- surface mount using standard flexible "boot" to allow

ILLUMINATED BOLLARDS

Bollards with integral light fixtures



Illuminated bollards may be integrated with other styles of bollards where additional or alternative lighting is desired. See the Lighting section of this document for illuminated bollard standards.



3.2 FURNISHING

SCREENING & FENCING

DESIGN RATIONALE

Fences and screening elements provide an additional level of security, privacy, and visual quality for the campus. While the University aspires to be an open and welcoming institution to the community, there are situations that necessitate a level of control and access to protect resources and ensure a safe environment is maintained. Additionally, the campus must be serviceable and maintainable, requiring the presence of functional and often unsightly site elements. Screening these elements helps to reduce the visual disruption they may cause.

Varying types of fences and screens address these different situations. Permanent fences provide physical control without creating a visual barrier. They are best used at the campus perimeter or in program areas that require controlled access, such as around sports fields and membership facilities. The design of permanent fences is subtle and clean, while also resisting climbing or vandalism.

Temporary fences and crowd control fences are low-cost and options for protecting sensitive resources during events and construction. Mesh fences offer a degree of visual filtering, while golf course-style rope and post systems are a visual indicator of access limits. Because these fence types use posts that are driven into the ground, rarely in the exact same locations, care should be taken to ensure underground utilities and systems are not damaged.

Vegetative screens are a tool for hiding unsightly elements with vegetation. They are a supplement to typical vegetative screening through shrubs and ornamental trees, and should be used selectively and with approval from LSU.

New projects on campus should take advantage of opportunities for screening and fences to be integrated into building design. Where possible, using complimentary materials and forms in fence and screen design will create a cohesive design expression. Considering and coordinating the systems of service, maintenance, and access during the design process ensures that undesirable site elements will not need to be added on in the future.

PERMANENT FENCES

Metal post and rail fence with open vertical slats

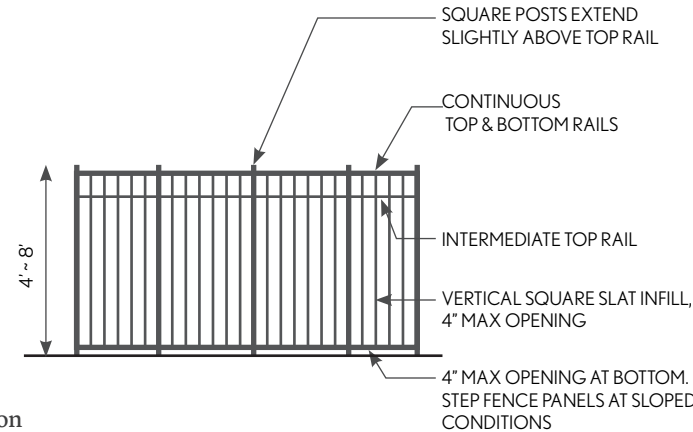
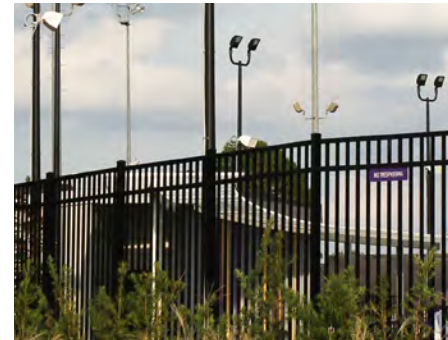

TYPE: SPECRAIL “Storrs” aluminum fence
 HEIGHT: Varies, 4’-8’ depending on application
 COLOR: Black Powdercoat
 INSTALLATION: Embedded post in planted areas; surface-mounted base plate in paved areas

TEMPORARY FENCES & CROWD CONTROL

Mesh and rope fences with temporary metal posts



HEIGHT: 4’ - 8’
 COLOR: Purple
 INSTALLATION: Driven metal T-post with woven mesh fencing attached by top tension rope and zip-ties



HEIGHT: 18” - 36”
 COLOR: White or Yellow rope & posts
 INSTALLATION: Driven metal or wood stakes with top loop or safety cap and loops for holding rope in place.

VEGETATIVE SCREEN

Welded wire mesh fence with climbing vegetation

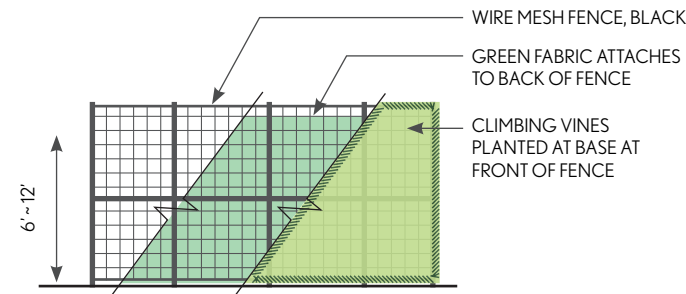

HEIGHT: 6’ - 12’ depending on screening needs
 COLOR: black fencing with dark green fabric
 INSTALLATION: Fence posts shall be embedded or surface mount to a cast-in-place footing. Attach mesh to fence with black zip-ties. Ensure sufficient soil volume and irrigation is provided for plants. See Vegetation section of this document for recommended plants.

SCREENING AS ARCHITECTURAL ELEMENT

Welded wire mesh fence with climbing vegetation

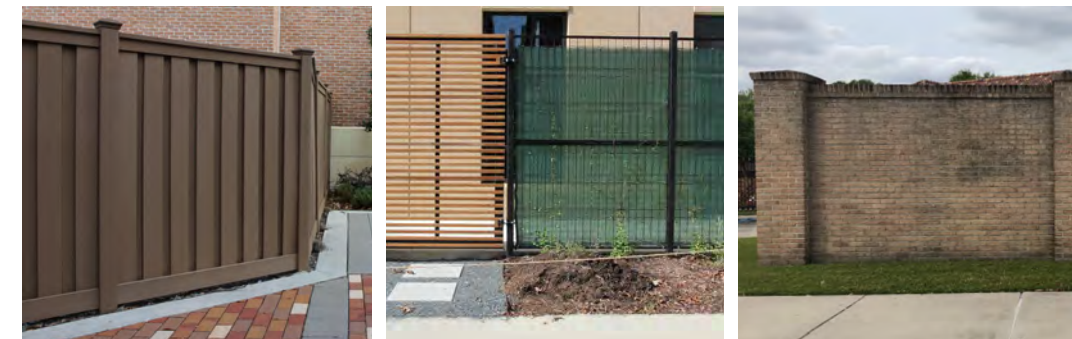

TYPE: TREX or similar synthetic wood materials. Real hardwoods may be used in certain architectural conditions with LSU approval
 HEIGHT: 6’ - 12’ depending on screening needs
 COLOR: Natural colors coordinated with adjacent architecture
 INSTALLATION: Typically pre-fabricated systems with embedded posts and interchangeable panels. Custom installations may be allowed with LSU approval.

3.2 FURNISHING

ART

DESIGN RATIONALE

Artwork, both professionally- and student-commissioned, is found throughout the LSU campus. Some areas of campus, such as the sculpture quad, function as outdoor galleries for student art. Primary building entries, campus gateways, and other prominent locations may feature professional works of art that are representative of the ethos or spirit of those spaces and programs. Typical site elements, such as benches and paving, may also serve as opportunities for artistic and sculptural expression. These elements bring unique interest and life to the campus, and their inclusion in landscape designs should be accommodated. However, all potential and proposed artwork on campus must be reviewed and vetted through the appropriate University and PDC process.



COMMISSIONED WORK



STUDENT WORK



FUNCTIONAL ART

WAYFINDING

DESIGN RATIONALE

Wayfinding and signage are critical elements of the campus experience. The University has developed a carefully detailed and thoughtful package of wayfinding standards to provide consistent, clear, and effective sharing of information across the campus. As many of these signage elements occur in the landscape, it is important for them to be carefully integrated into all landscape and site designs. Designers working on campus projects should reference and familiarize themselves with the LSU Wayfinding Guidelines early in a project to understand the expectations for signage design. These site & landscape standards are based on the information in that document, and offer additional guidance for the appropriate siting of campus wayfinding.





3.3 LIGHTING

LANDSCAPE LIGHT FIXTURES

These diagrams provide an overall guide for the selection and placement of exterior light fixtures on campus with the goal of unifying the lighting on campus to one cohesive vision and set of standards. See following pages for more detail on each fixture type.

ACCEPTED STANDARD CONFIGURATIONS

- ① Pathway Pole Fixture - standard pedestrian-scale fixture and pole to be used at pathways, courtyards, and building entries.
- ② Alternate Pathway Pole Fixture - previously used standard fixture should only be used for consistency where similar fixtures exist.
- ③ Roadway & Parking Pole Fixture - standard fixture at extended height, to be used at internal roadways, single-bay and small parking areas, or where paths or sidewalks are adjacent to either condition above and a single-pole solution is desired.
- ④ Vehicular Scale Fixture - to be used at medium and large surface parking lots, along major roads, and where additional high-mast lighting is required in open spaces. This fixture should not be used in smaller parking lots on the interior of campus.
- ⑤ Illuminated Bollards - may be used, but not be relied on, to provide the necessary levels of lighting in pedestrian circulation and gathering areas. They are typically used to distinguish an edge or traffic control and are used in conjunction with standard non-illuminated bollards.
- ⑥ Specialty - poles mounted, ground mounted accent lighting, and bollard lighting may be used in plazas, promenades, major building entries, and residential courtyards. These styles of lighting may only be used with review and permission of LSU. Ground mounted uplights requires protection from lawn equipment and should be used on walls and underside of canopies while considering glare.

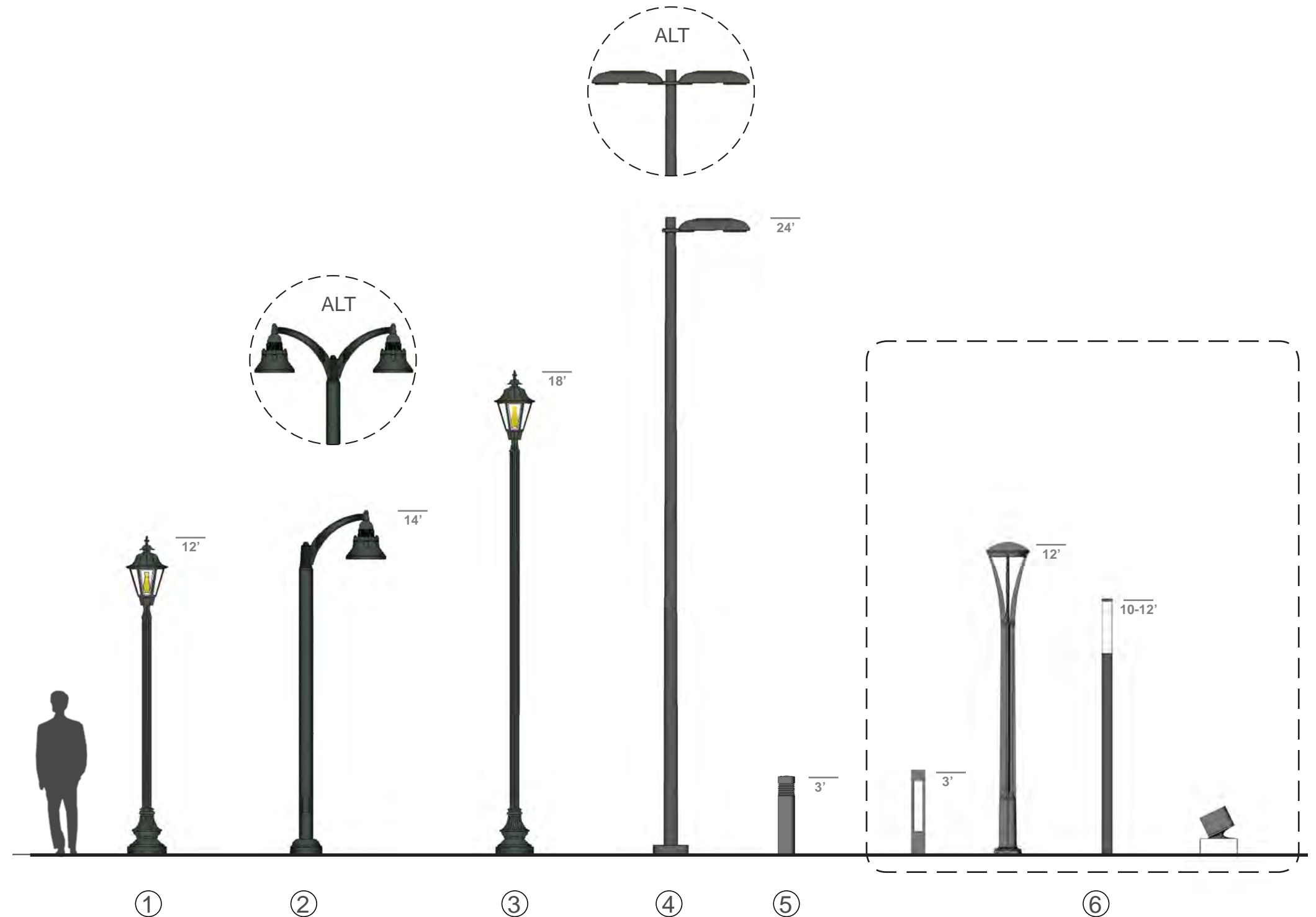

NON-STANDARD ELEMENTS TO AVOID

- ⑦ In-grade Fixtures - Due to the nature of the sites throughout the LSU campus, water ingress has been an issue with in-grade lighting. Fixtures that are lifted off the ground are recommended when needing to uplight elements.

- ⑧ Outdated Fixtures - The current lighting system on campus uses many styles and models of pedestrian-scale light fixture. New building and renovation projects should remove and replace these lights with the standard pedestrian fixture (#1, previous page) where budget and scope allow.

- ⑨ Mixing Poles / Scales - The performance and quality of lighting as well as the daytime aesthetics are compromised when pedestrian scale fixtures are used to light large parking lots or plazas in this manner. Where locations or lighting demands dictate, use fixtures on the previous page, or increase the number of poles and fixtures in the site design.

- ⑩ Industrial High Mast Fixtures - Similar to #3 above, high-mast light fixtures at the edges of parking lots, open spaces, and roadways provide inconsistent light levels and low-quality light and color rendering. Use appropriately scaled and spaced parking lot and roadway fixtures.

- ⑪ Extra Elements on Poles - The cobra-head style pole fixture is common along roadways and drives throughout campus. Though this pole and fixture should be phased out where possible, it serves as suitable means of illuminating vehicular spaces and is easily differentiated from pedestrian-scale lighting. However — light packs, box fixtures, and other pedestrian scale fixtures should not be attached to a cobra head pole. Security cameras may be mounted to these roadway poles where necessary.

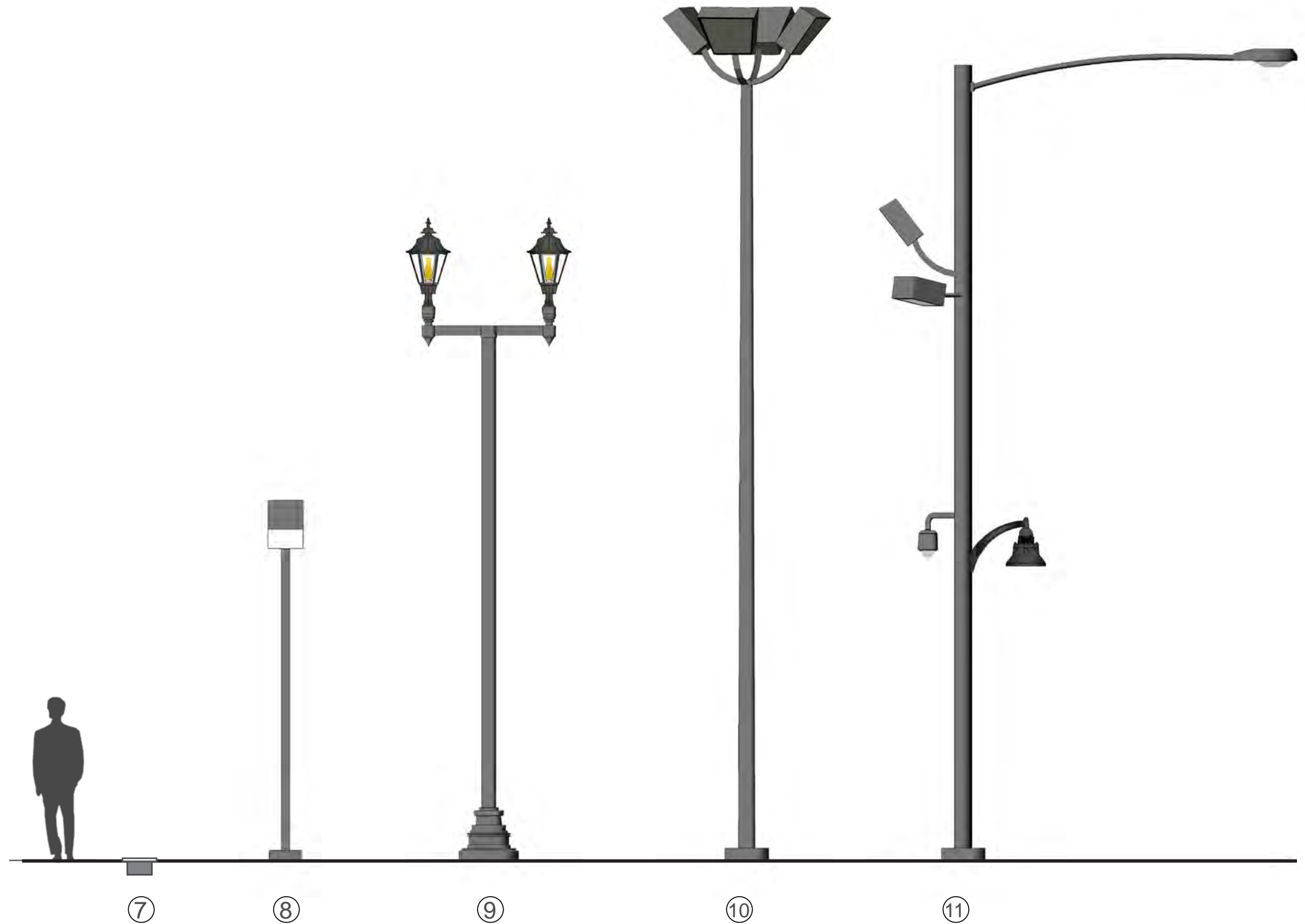



3.3 LIGHTING

PATHWAY POLE FIXTURES

DESIGN RATIONALE

Pedestrian-scale pole lighting provides lighting for pedestrians to traverse the campus. Having appropriately scaled fixtures will add to the overall ambiance and adds positively to the perception of safety of the campus.

Lighting design for pathways on LSU campus shall be guided by the listed Pathway Pole options. *Pathway Pole Type 1* shall be used as a standard. When a contemporary approach is desired in a prominent pathway on campus, *Pathway Pole 2* shall be used with permission from LSU. Other approved comparable pathway pole options may be used as well.

Light levels of pathways shall aim to meet industry standard recommendations. (Refer to Section 3.3: LIGHTING – Suggested Light Levels). Where pathway(s) and/or roadway(s) intersect, use appropriate higher light levels. Where pathways are connected to roadways, a similar pole aesthetic shall be used for roadways with a design rationale as described in the previous section (Roadway Poles).

Height of pathway Poles is recommended to be 12'. Spacing of poles can range between 25' and 30' depending on application and fixture. In case other spacing ranges are desired, a lighting calculation shall be performed to confirm that recommended illuminance levels are met.

Concrete pole base shall be added as required. The design of pole bases shall be minimal. Poles within trafficked parts of parking lots should have a 3' above grade concrete footing to prevent damage from vehicular strikes.

In case an object is desired to be attached to any light pole, attachment accessories shall be provided by light pole manufacturer. The use of third-party attachment accessories is discouraged.

All pathway poles shall have a Correlated Color Temperature (CCT) of 3500K with a minimum of 80+ CRI.

All fixtures shall be LED, and overall design shall comply with relevant energy codes.



Sternberg Heritage Pedestrian LED



Acuity Antique TL26



Neri Lighting 700



Sun Valley LCB

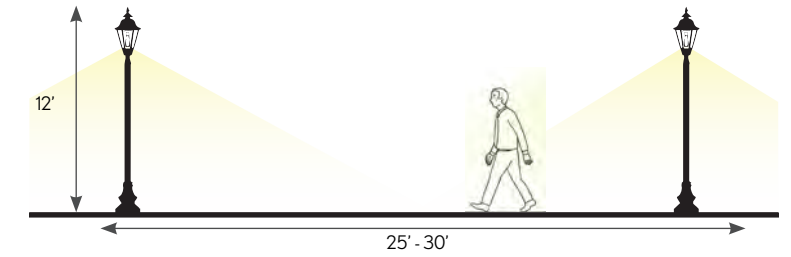

Typical Height and Spacing. All spacing and layout should be confirmed by engineered lighting calculations.

PATHWAY POLE TYPE 1

MODEL : Sternberg Heritage
 OVERALL HEIGHT : 12'
 FINISH : Black
 LUMENS : 4000 LM
 DISTRIBUTION : Type II
 CCT : 3500K
 SPACING : 25-30 feet

RECOMMENDED ALTERNATES:
 Acuity Antique TL26
 Neri Lighting 700
 Sun Valley LCB



Landscapeforms - Alcott Series Type 3



Alt 2 - Kim Lighting, Era RA25

PATHWAY POLE ALTERNATE

HEIGHT : 12' - 16'
 FINISH : Black
 LUMENS : 2400 LM
 DISTRIBUTION : Type II
 CCT : 3500K
 SPACING : 30 feet
 NOTE: Fixture can be used in more contemporary environments but requires permission from LSU.

RECOMMENDED ALTERNATES:
 Landscapeforms Alcott Type 3
 Kim Lighting Era RA25



Sternberg Light on LSU Campus



Outdated Non Standard Fixture



Kim Era RA25

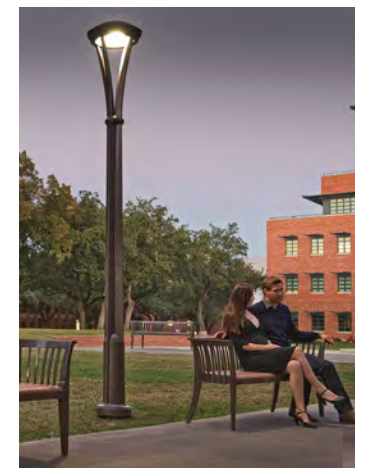

Landscapeforms Alcott

3.3 LIGHTING

ROADWAY & PARKING POLE FIXTURES

DESIGN RATIONALE

Roadway poles provide needed light primarily for vehicular travel, but also might provide lighting for adjacent sidewalks. Having sidewalks lit adds to the perception of safety and allows pedestrians to be more visible to vehicles.

Lighting design for roadways on the LSU campus shall be guided by the listed Roadway Pole options. For general roads and smaller parking lots, *Roadway Pole 1* shall be used. For larger streets, large parking lots, or back out house streets, *Roadway 2* shall be used. Other approved comparable roadway pole options may be used as well.

Light levels of roadways shall aim to meet industry standard recommendations. (Refer to Section 3.3: LIGHTING – Suggested Light Levels). Where roadway(s) and/or pathway(s) intersect, use appropriate higher light levels. Where roadways are connected to pathways, a similar pole aesthetic shall be used for pathways with a design rationale as described in the following section (Pathway Poles).

Height of roadway poles is recommended to be 18'. Spacing of poles can range between 25' and 35' depending on application and fixture. In case other spacing ranges are desired, a lighting calculation shall be performed to confirm that recommended illuminance levels are met.

Concrete pole bases shall be added as required. The design of pole bases shall be minimal.

In case an object is desired to be attached to any light pole, attachment accessories shall be provided by light pole manufacturer. The use of third party attachment accessories is discouraged. Pole specification to be calculated to meet pole/fixture/accessory estimated projected area wind loads. Use breakaway arms as necessary.

All fixtures shall have a Correlated Color Temperature (CCT) of 3500K with a minimum of 80+ CRI.

All fixtures shall be LED, and overall design shall comply with relevant energy codes.



Sternberg Heritage Campus Standard Pedestrian LED



Acuity Antique TL26

ROADWAY AND SM PARKING LOT POLE

MODEL: Sternberg Heritage Campus Standard Pedestrian LED
 OVERALL HEIGHT: 18'
 FINISH: Black
 LUMENS: 5000 LM
 DISTRIBUTION: Type III, Type V
 CCT: 3500K
 SPACING: 35 - 45 ft

RECOMMENDED ALTERNATES:
 Acuity Antique TL26



Gardco Pureform LED



Hess Trapez 450



Luminis Pelican

LARGE ROADWAY AND PARKING LOT POLE

MODEL: Gardco Pureform LED
 OVERALL HEIGHT: 24'
 FINISH: Black
 LUMENS: 5500 LM
 DISTRIBUTION: Type III, Type V
 CCT: 3500K
 SPACING: 45 - 55 ft

Vehicular Only / Parking Lot / Low Priority Street

RECOMMENDED ALTERNATES:
 Hess Trapez 450
 Luminis Pelican PL30P

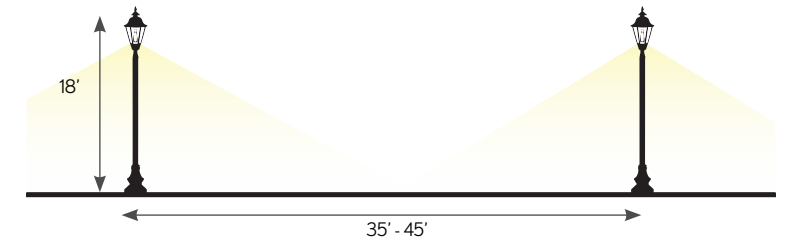

Typical Height and Spacing. All spacing and layout should be confirmed by engineered lighting calculations.



Example of pole with integrated banners



LSU Campus - Consider scale when selecting pole heights

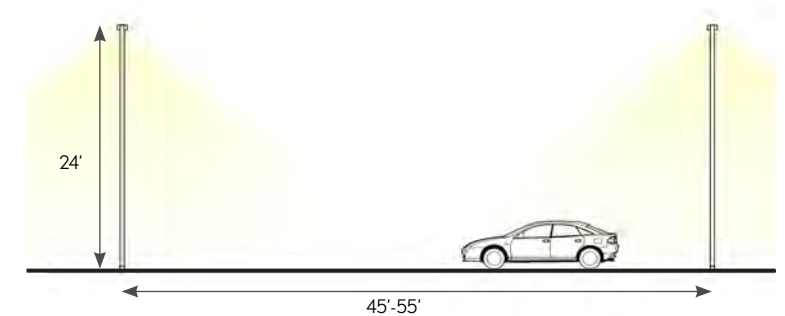

Typical Height and Spacing. All spacing and layout should be confirmed by engineered lighting calculations.



3.3 LIGHTING

ILLUMINATED BOLLARDS

DESIGN RATIONALE

Bollards provide lower level path lighting to smaller paths and where pole lighting is not appropriate. The lower position of the light source is also has a lower potential for glare.

Illuminated Bollards on LSU campus shall be guided by the listed Illuminated Bollard options. When a minimal approach is desired, *Illuminated Bollard 1* shall be used. Other approved comparable illuminated bollard options may be used as required. Illuminated bollards are not intended to have impact ratings to stop moving vehicles. Their intended function is to provide appropriate light levels. Alternate decorative bollards may only be used with permission from LSU.

Light levels of areas where illuminated bollards are used shall aim to meet industry standard recommendations. (Refer to Section 3.3: LIGHTING – Suggested Light Levels). Height of illuminated bollards could range between 3’ and 4’. Spacing of illuminated bollards could range between 12’ and 15’. Lighting calculations shall be performed to confirm design spacing meets the recommended illuminance level.

It is recommended to mount bollards on hardscape, provided that hardscape is wide enough for safe circulation. Should illuminated bollards be mounted on softscape, concrete bases shall be added as required. The design of concrete bases shall be as minimal as possible while meeting manufacturer recommendations and required applicable loads. Limit portion of footing that extends above softscape grade to 3” height. Footing to be flush for hardscape installation conditions.

All illuminated bollards shall have a Correlated Color Temperature (CCT) of 3500K with a minimum of 80+ CRI.



Bega - 99 853 Series



We-ef Lighting - ZFY200



iGuzzini - iWay Round

ILLUMINATED BOLLARD 1

MODEL : Bega - 99865 Series
 DIMENSIONS : 34.5” X 10.5”
 FINISH : Black
 LUMENS : 1,654 LM
 DISTRIBUTION : Type V
 CCT : 3500K
 SPACING : 12’ - 15’

RECOMMENDED ALTERNATE:
 We-ef Lighting - ZFY200
 iGuzzini - iWay Round

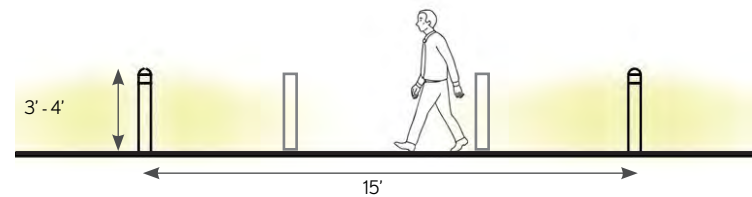

Typical Height and Spacing
 Rendering shows illuminated bollards intermixed with non-illuminated bollards. Verify spacing with engineered lighting calculations.



LSU Campus - use of bollards as primary illumination not recommended



LSU Campus - Good use of performance bollards



LSU Campus - Good use of decorative bollards. Decorative bollards to be used on a case by case basis with approval from LSU.

3.3 LIGHTING

ACCENT & UP LIGHTING

DESIGN RATIONALE

Accent lighting is to be used to highlight landmarks and key elements of an area, and to create visual interest. Uplighting softscape elements, such as trees, adds to the overall ambiance of a space. Most accent and uplight does not provide egress lighting—therefore other sources of lighting are needed in addition to accent / uplight—but provide visual brightness to help a space feel better illuminated.

Accent lighting on LSU campus shall be guided by the listed Accent Lighting options. When building façade lighting is desired, *Accent Light 1* shall be used. When feature element (a monument or trees, for example) accent lighting is desired, *Accent Light 2* or *Accent Light 3* shall be used, depending on the scale of the element and the desired lighting effect. Other approved comparable accent lighting options may be used as required.

When uplighting trees, only uplight mature trees. When projects have new trees, conduit runs might be included for future tree uplight locations.

For wall wash situations, consider glare where people cross paths with the beam of light.

Light levels on feature elements shall aim to meet industry standard recommendations. (Refer to Section 3.3: LIGHTING – Suggested Light Levels). Use appropriate spacing between fixtures and elements depending on the light fixture lumens, distribution, and the desired lighting effect on what is being lit.

All fixtures shall have a Correlated Color Temperature (CCT) of 3500K with a minimum of 80+ CRI.

All fixtures shall be LED, and overall design shall comply with relevant energy codes.



Lumenpulse - Lumenbeam

ACCENT LIGHT 1

MODEL: LumenPulse - LumenBeam
 DIMENSIONS : 15" Diameter
 FINISH : Per Architecture
 LUMENS : Application Dependent
 DISTRIBUTION : Application Dependent
 INSTALLATION : Surface Mounted
 CCT : 3500K
 NOTES : Lumens, distribution are dependent on what is being lit.



BK-NiteStar

ACCENT LIGHT 2

MODEL: BK-NiteStar
 HEIGHT : 2" D X 5"L
 FINISH : Black
 LUMENS : 300 - 500 LM
 DISTRIBUTION : Medium / Wide
 INSTALLATION : Stake Mounted
 CCT : 3500K
 NOTES : Use to light landscape features such as trees. Use glare control accessory as required. Fixture to have integral aiming knuckle.



Ligman - Odessa Cluster Spike Pole

ACCENT LIGHT 3

MODEL: Ligman - Odessa
 DIMENSIONS : 6" - 11" Diameter
 FINISH : Black
 LUMENS : 1100 LM
 DISTRIBUTION : Medium / Wide
 INSTALLATION : Pole Mounted
 CCT : 3500K
 NOTES : Use to highlight plaza elements or landscape

Ground Mounted Adjustable Flood Light / Facade Light

RECOMMENDED ALTERNATES:
 ColorKinetics - eW Reach Series

NOTES : Lumens, distribution are dependent on what is being lit.

Ground Mounted Adjustable Uplight / Landscape Accent

RECOMMENDED ALTERNATES:
 Lumiere - Cambria 203 Series

Pole-mounted Accent Lights

RECOMMENDED MANUFACTURED MODELS:
 Selux Olivio
 Bega 77 685 Series

NOTE: Uplight of signage should be coordinated with wayfinding standards document.

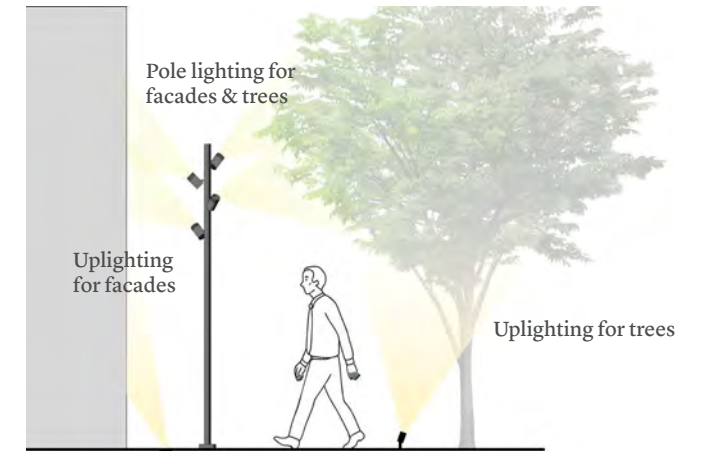

Accent Lighting Diagram



Tree Lighting at UREC - Avoid over uses of accent lighting and out of scale lighting



Good Tree Uplight Example



LSU Campus - Example of accent lighting. Lighting effect could be improved by more even illumination of the tower and standardization of color temperature of lighting elements. Tower is a good color while lower level lighting is very orange.



3.3 LIGHTING

EMBEDDED LIGHTS

DESIGN RATIONALE

Embedded lighting can be used where clearance space is limited, since in-grade and wall-mounted lighting does not impede on walking area. In-grade fixtures should be used sparingly as the LSU campus is a moisture rich environment.

Embedded lighting on LSU campus shall be guided by the listed embedded light options. Use embedded in-grade lighting to uplight features and embedded step and wall lights to light pathways. Embedded lights should only be used in surfaces that allow for easy maintenance and removal.

Light levels of areas where embedded mounted lights are used shall aim to meet industry standard recommendations. (Refer to Section 3.3: LIGHTING – Suggested Light Levels). Spacing of embedded step and wall lights could range between 8 and 10'. Lighting calculations shall be performed to confirm design spacing meets the recommended illuminance level.

All fixtures shall have a Correlated Color Temperature (CCT) of 3500K with a minimum of 80+ CRI.

All fixtures shall be LED, and overall design shall comply with relevant energy codes.



BK-WellStar

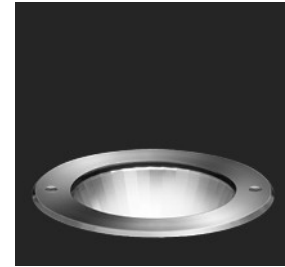

BEGA 77812



Hydrel M9800

IN-GRADE LIGHT

MODEL: BK-WellStar
 DIMENSIONS: 5" DIAMETER
 FINISH: Black
 LUMENS: 300-500
 DISTRIBUTION: Narrow-Wide
 INSTALLATION: In-grade
 CCT: 3500K
 NOTES: Use to light landscape features. Can be installed in landscape or hardscape.

RECOMMENDED ALTERNATES:

BEGA 77812
 Hydrel M9800



Bega - 22056 Series (Round)



Bega - 2378 Series (Square)



Systemalux Blinker

STEP & WALL LIGHTS

MODEL: Bega - 22056 Series (Round) RECOMMENDED ALTERNATES:
 DIMENSIONS: 7" DIAMETER Bega - 2378 Series (Square)
 FINISH: BLACK Systemalux Blinker
 LUMENS: 700 LM
 DISTRIBUTION: Wide
 INSTALLATION: Recessed Wall
 CCT: 3500K



LSU Campus - Avoid in-grade fixtures where possible. LSU has had maintenance issues in the past with in-grade lighting.

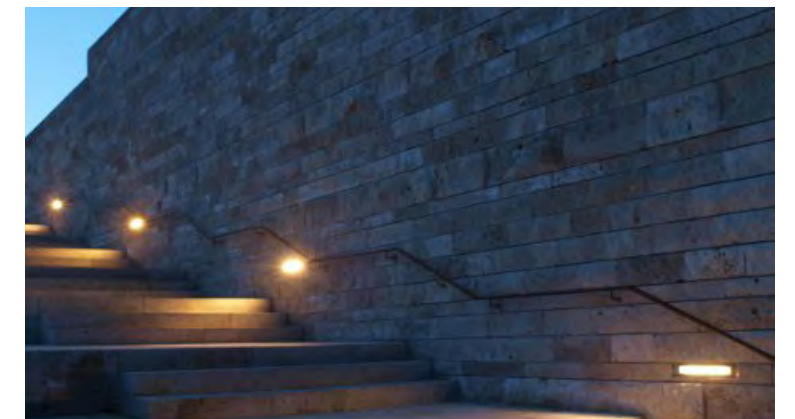

Photo Credit - Bega Lighting - Example of step lights for stairs

3.3 LIGHTING

WALL-MOUNTED LIGHTS

DESIGN RATIONALE

Wall-mounted fixtures have very flexible applications. They can be used to light walkways or highlight entrances for wayfinding. Different styles of wall-mounted lights should complement to the building they are mounted on.

Wall-mounted lighting on LSU campus shall be guided by the listed Wall-Mounted Light options. The standard, *Wall-Mounted Light 1* shall be used throughout the campus. Where the architecture is more contemporary, *Wall-Mounted Light 2* shall be used with permission from LSU. When lighting is desired for an alley between buildings or a Back of House (BOH) area (i.e. loading dock), *Wall-Mounted Light 3* shall be used. Other approved comparable wall-mounted light options may be used as required.

Light levels of areas where wall-mounted lights are used shall aim to meet industry standard recommendations. (Refer to Section 3.3: LIGHTING – Suggested Light Levels). Mounting height of wall-mounted lights could range between 7’ and 12’ for most wall-mounted light fixtures. For areas where wall-mounted lights need to be arrayed along a line (i.e. an alley between buildings), 10’ mounting height is recommended with a spacing that can range between 30’ and 40’ for *Wall-Mounted Light 3*.

All fixtures shall have a Correlated Color Temperature (CCT) of 3500K with a minimum of 80+ CRI.

All fixtures shall be LED, and overall design shall comply with relevant energy codes.



Sternberg Heritage Wall-Mounted



Sternberg Heritage Chain Hung

WALL-MOUNTED LIGHT 1

MODELS: STERNBERG HERITAGE
 DIMENSIONS: 12”H X 14”W X 13”D
 FINISH: Black
 LUMENS: 725 LM
 DISTRIBUTION: Wide
 INSTALLATION: Wall Surface
 CCT: 3500K
 NOTES: Suggested use for either or both side(s) of an entry door.

Classic

RECOMMENDED ALTERNATES:
 Bega - 66411 Series
 Teka BWM
 Ligman Atlantic Shepherds Crook

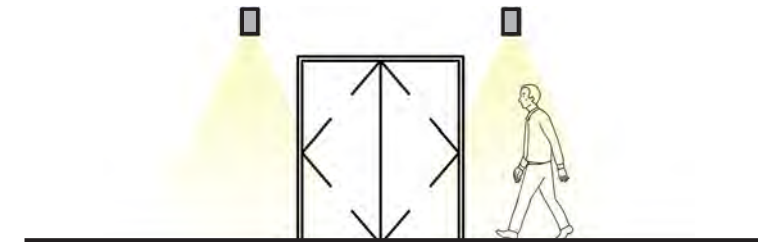

Wall Light Diagram - Example Mounting



Photo Credit - Systemalux



Bega - 24008 Series

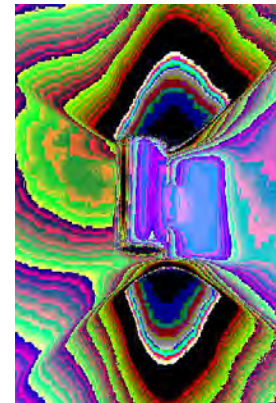

Systemalux Slot Round

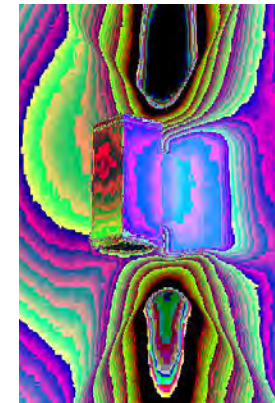

Systemalux Slot Square

WALL-MOUNTED LIGHT 2

MODEL: Bega - 24008 Series
 DIMENSIONS: 19”H X 5”W X 4”D
 FINISH: Black
 LUMENS: 2200 LM
 DISTRIBUTION: Medium
 INSTALLATION: Wall Surface
 CCT: 3500K
 NOTES: Suggested use for either or both side(s) of an entry door.

Contemporary

RECOMMENDED ALTERNATES:
 Systemalux Slot Round
 Systemalux Slot Square



Bega - 33395 Series (Up/Down)



Ligman ULD 30021

WALL-MOUNTED LIGHT 3

MODEL: Bega - 22383 Series
 DIMENSIONS: 9”W X 6”H X 7”D
 FINISH: Black
 LUMENS: 5000 LM
 DISTRIBUTION: Wide
 INSTALLATION: Wall Surface
 CCT: 3500K
 NOTES: Suggested use for alleys and BOH areas.

Performance Oriented

RECOMMENDED ALTERNATES:
 Ligman ULD 30021



3.3 LIGHTING

CEILING LIGHTS

DESIGN RATIONALE

Ceiling lighting is a great way to illuminate covered areas. Ceiling lighting should generally be specified by the Architect (not landscape or site designers) but coordinated with all parties.

Ceiling mounted lighting on LSU campus shall be guided by the listed Ceiling Mounted Light options. When ceiling conditions allow for recessed fixtures, the use of *Ceiling Mounted Light 1* is recommended. When ceiling conditions do not have sufficient recessed space or there are other limitations, *Ceiling Mounted Light 2* shall be used.

Light levels of areas where ceiling mounted lights are used shall aim to meet industry standard recommendations. (Refer to Section 3.3: LIGHTING – Suggested Light Levels). Spacing of lights could range between 10’ and 12’ in the case where ceiling height is 12’. Lighting calculations shall be performed to confirm design spacing meets the recommended illuminance level.

All fixtures shall have a Correlated Color Temperature (CCT) of 3500K with a minimum of 80+ CRI.

All fixtures shall be LED, and overall design shall comply with relevant energy codes.



USAI - BeveLED Mini Series



Lucifer Fraxion 3



Tech Element Lighting 3 Inch

CEILING LIGHT 1

MODEL: USAI - BeveLED / BeveLED
 Mini Series
 DIMENSIONS: 3” - 5” Diameter
 FINISH: Coordinate with ceiling
 LUMENS: 1,100 LM
 DISTRIBUTION: 50°
 CCT: 3500K
 SPACING: 10’ - 12’

Recessed Downlight

RECOMMENDED ALTERNATES:
 Lucifer Fraxion 3 / Fraxion 4
 Tech Element Lighting 3 Inch

Note: Wet location trim recommended for outdoor applications but not required.



USAI - BeveLED Block Series



Lucifer Lighting CY3



BK Lighting Alpine

CEILING LIGHT 2

MODEL: USAI - BeveLED Block Series
 DIMENSIONS: 6” Diameter X 7”
 FINISH: Match ceiling
 LUMENS: 1,150 LM
 DISTRIBUTION: 50°
 CCT: 3500K
 SPACING: 10’ - 12’

Surface Mounted Downlight

RECOMMENDED ALTERNATES:
 Lucifer Lighting CY3
 BK Lighting Alpine

Note: Ceiling lights that protrude should be used for retrofit situations only; otherwise use embedded ceiling lights.

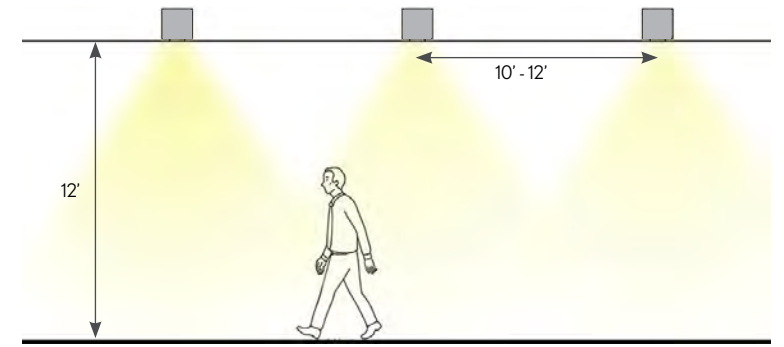

LSU Campus - Example of recessed downlighting along exterior corridor

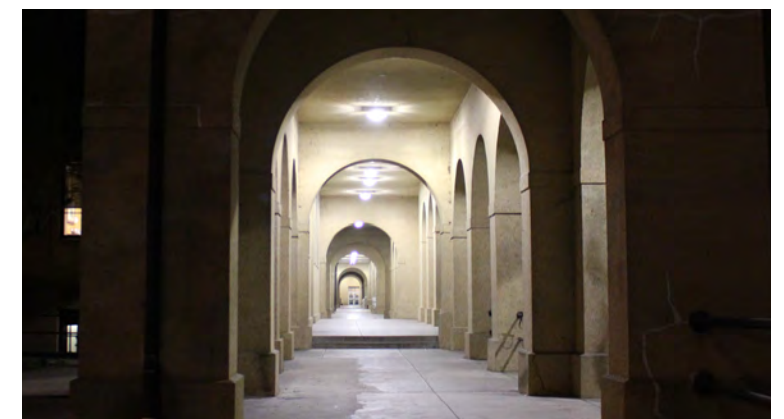
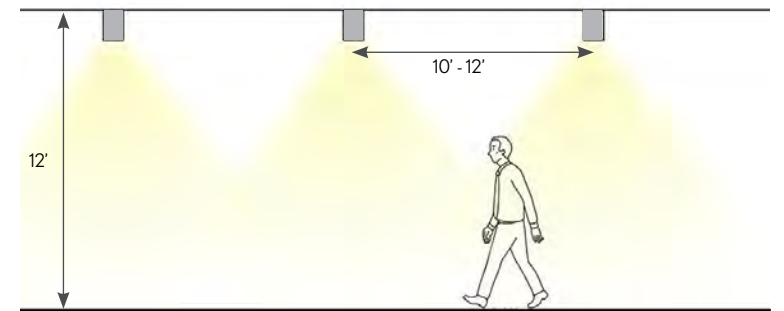

LSU Campus - Example of surface mounted downlights.

3.3 LIGHTING

RECOMMENDED ILLUMINATION LEVELS

Refer to the light level charts for lighting industry (IES) recommended light levels for different spaces. These light levels are to be used as a reference to determine the appropriate amount of light for a space for the feel and perception of safety. Refer to current version of recommendations as updates are issued by the IES. These are not building code required light levels. Refer to local code for code minimum required light levels.

Balance light levels with local energy code to ensure code compliance.

Even downward facing light contributes to upward light pollution. Consider light pollution when planning light levels needed.

Consider illuminating vertical surfaces to make spaces feel brighter, instead of only adding lighting to the horizontal walking surfaces.

Lighting levels shown here are provided only as a guide. Designers must provide light level calculations and documentation of coordination between fixtures, spacing, and light levels.

Space Typology	Recommended Maintained Targets		Recommended Uniformity Target	Notes
	(Horizontal Illuminance Target [Fc]) unless otherwise noted	Gauge	(Avg:Min) unless otherwise noted	

Streets				
Major				
High Pedestrian Area	1.2*	Avg		3:1
Medium Pedestrian Area	0.9*	Avg		3:1
Low Pedestrian Area	0.6*	Avg		3.5:1
Collector				
High Pedestrian Area	0.8*	Avg		3:1
Medium Pedestrian Area	0.6*	Avg		3.5:1
Low Pedestrian Area	0.4*	Avg		4:1
Local				
High Pedestrian Area	0.6*	Avg		6:1
Medium Pedestrian Area	0.5*	Avg		6:1
Low Pedestrian Area	0.3*	Avg		6:1
Intersections				
Major/Major				
High	3.4	Avg		3:1
Medium	2.6	Avg		3:1
Low	1.8	Avg		3:1
Major/Collector				
High	2.9	Avg		3:1
Medium	2.2	Avg		3:1
Low	1.5	Avg		3:1
Major/Local				
High	2.6	Avg		3:1
Medium	2	Avg		3:1
Low	1.3	Avg		3:1
Collector/Collector				
High	2.4	Avg		4:1
Medium	1.8	Avg		4:1
Low	1.2	Avg		4:1
Collector/Local				
High	2.1	Avg		4:1
Medium	1.6	Avg		4:1
Low	1	Avg		4:1
Local/Local				
High	1.8	Avg		6:1
Medium	1.4	Avg		6:1
Low	0.8	Avg		6:1

These figures refer to vehicular zone.

Transit Ways				
Transit Hubs (Bus Stops)				
Covered				
High Activity	3	Avg		2:1
Medium Activity	1.5	Avg		2:1
Low Activity	0.8	Avg		2:1
Uncovered				
High Activity	1	Avg		2:1
Medium Activity	0.6	Avg		2:1
Low Activity	0.02	Avg		2:1

Service Areas				
High Activity	1.5	Avg		3:1
Medium Activity	1	Avg		3:1
Low Activity	0.8	Avg		3:1

Parking				
Car Surface Parking				
Asphalt Surfaces				
Pre-curfew	0.5	Min		4:1
Post-curfew	0.2	Min		4:1
Concrete Surfaces				
Pre-curfew	1	Min		4:1
Post-curfew	0.2	Min		4:1
Bike Parking				
General	1	Min		4:1

Values in this chart are based on the 10th edition of the IES Handbook, ANSI/IES RP-8-14, ANSI/IES RP-20-14, and ANSI/IES RP-33-14.
 Values in this chart are recommended levels for visual ages 25 to 65 years.
 Values in this chart do not consider required egress light levels, nor light levels to mitigate crime and vandalism.
 Min and Max levels could be determined using the recommended Avg and its associated uniformity target.

Parking				
Car Surface Parking				
Asphalt Surfaces				
Pre-curfew	0.5	Min		4:1
Post-curfew	0.2	Min		4:1
Concrete Surfaces				
Pre-curfew	1	Min		4:1
Post-curfew	0.2	Min		4:1
Bike Parking				
General	1	Min		4:1

Pedestrian Circulation				
Sidewalks / Major Paths / Secondary Circulation Spines				
Pedestrian Sidewalks and Bikeways				
High Pedestrian Conflict Areas (Mixed vehicle and pedestrian)	2	Avg		4:1
High Pedestrian Conflict Areas (Pedestrian only)	1	Avg		4:1
Medium Pedestrian Conflict Areas	0.5	Avg		4:1
Pedestrian Malls / Major Circulation Spine / Plazas / Courtyards / Quadrangles				
High Activity	0.6	Avg		5:1
Medium Activity	0.4	Avg		5:1
Low Activity	0.2	Avg		5:1
Building Entries				
Canopied				
High Activity	3	Avg		2:1
Medium Activity	1.5	Avg		2:1
Low Activity	0.8	Avg		2:1
Non-Covered				
High Activity	1	Min		2:1
Medium Activity	1	Min		2:1
Low Activity	1	Min		2:1
Porte Cocheres				
High Activity	5	Avg		2:1
Medium Activity	3	Avg		2:1
Low Activity	1.5	Avg		2:1
Paths to Curb				
High Activity	1	Avg		3:1
Medium Activity	0.6	Avg		3:1
Low Activity	0.2	Avg		3:1

Urban Frontages				
Façade Details or Features with Surface Reflectance >= 0.5				
High Activity	15**	Max		N/A
Medium Activity	7.5**	Max		N/A
Low Activity	4**	Max		N/A
Façade Details or Features with Surface Reflectance <0.5				
High Activity	30**	Max		N/A
Medium Activity	15**	Max		N/A
Low Activity	7.5**	Max		N/A
Façade Fields with Surface Reflectance >= 0.5				
High Activity	5**	Avg		10:1
Medium Activity	3**	Avg		10:1
Low Activity	1.5**	Avg		10:1
Façade Fields with Surface Reflectance <0.5				
High Activity	10**	Avg		10:1
Medium Activity	5**	Avg		10:1
Low Activity	3**	Avg		10:1

Apply strategically to <=20% of area of building façade.

Landscaped Edges				
Parks / Large Open Spaces				
High Activity	1 - 3	N/A		N/A
Medium Activity	0.6 - 0.8	N/A		N/A
Low Activity	0 - 0.4	N/A		N/A
Intramural Playing Fields*****				
General				
	30-50	N/A		N/A
Baseball				
Infield	50	Avg		2:1****
Outfield	30	Avg		2:1****
Basketball				
	50	Avg		3:1****
Lacrosse				
	30	Avg		3:1****

* Average Luminance (cd/m²)
 ** Vertical F.C. values
 *** Horizontal Illuminance taken at 3' above competition surface
 **** (Max:Min)
 ***** For recreational sports fields. Refer to IES handbook or other standard for collegiate level sports and stadium lighting.



3.4 TOPOGRAPHY

LANDFORM & SOILS

The Highland Ridge escarpment played a major role in the siting and structure of the historic core of campus, serving as the primary organizing feature opposite of the Highland Road axis. The original campus buildings were positioned on an upland plateau overlooking the Mississippi River floodplains. Buildings adjacent the Ridge Rider were designed to take advantage of the grade change, with direct service access provided at the basement levels. Others overlooked the agricultural fields that filled the swampy floodplains. The designation between “highland” and “lowland” used to describe areas of plateau and floodplain has implications on natural systems of soil, horticulture, and hydrology.

As the campus grew outwards from the original core, the The Highland Ridge has come to define two general areas of campus distinguished by program, building scale, and open space character. Original campus buildings in upland areas are primarily academic or residential, smaller in scale, and form some of the most iconic landscape on campus. In lowland areas, vast open spaces are occupied by large athletic facilities, surface parking lots, and newer academic buildings that are scaled to accommodate the larger footprints of lab and research spaces.

Future building and landscape projects should thoughtfully consider this change in topography and its implications for the scale and character of landscape spaces as well as systems of circulation, soils, plant palette, and stormwater management.

HIGHLAND RIDGE

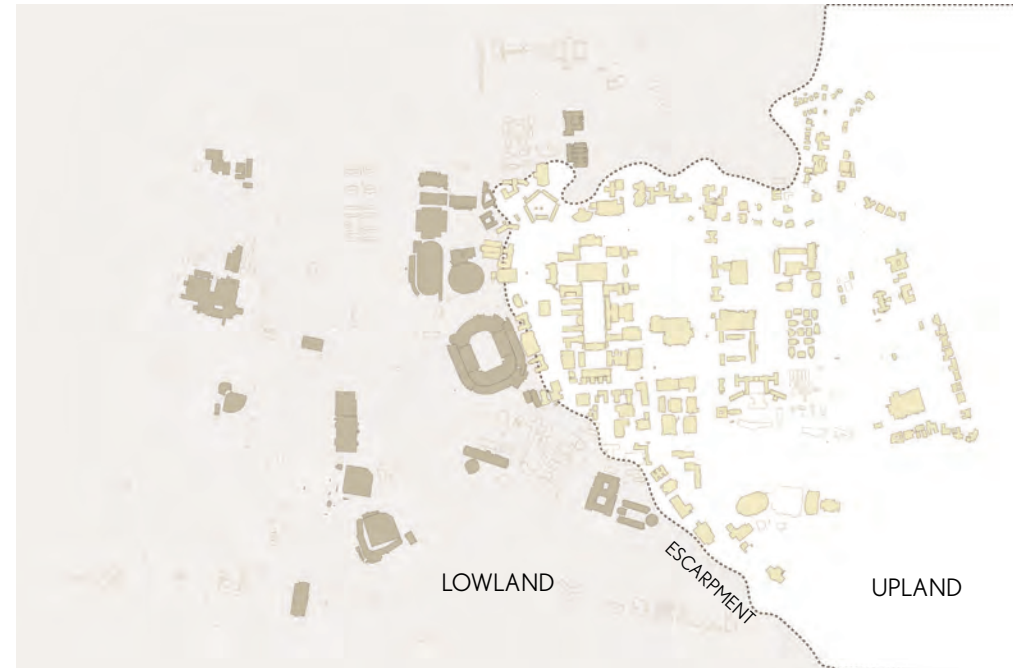

Mapped from GIS topography

SOIL TYPES

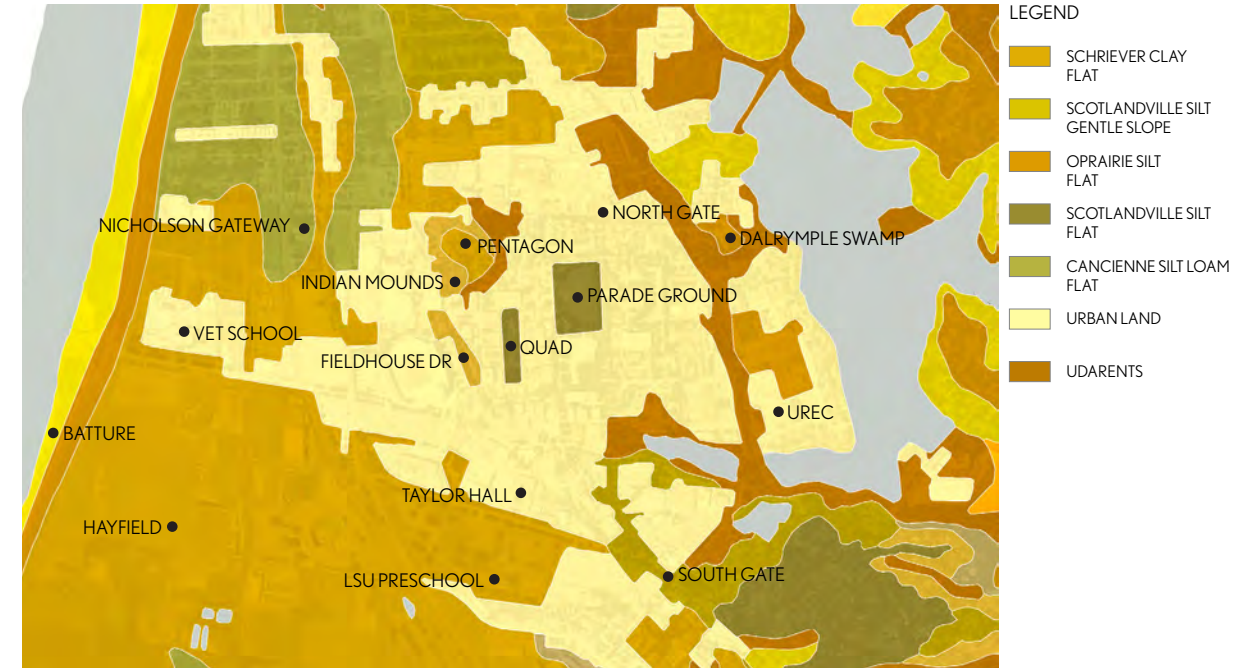

(Source: USDA)

DESIGNING WITH TOPOGRAPHY



The Comprehensive Campus Master Plan envisions a spine of connected open spaces extending along the Highland Ridge escarpment. Landscape designs for these spaces should express their unique relationship to the landform through use of diverse vegetation, accessible circulation, hydrologic function, and built landscape features.



3.4 TOPOGRAPHY

RAMPS & SLOPED WALKS

DESIGN RATIONALE

Ramps are used to provide an accessible route to buildings and gathering spaces in areas with grade changes that exceed the allowed slope for a sidewalk. With many campus buildings outdating the expanded accessibility requirements included in the Americans with Disabilities Act, retrofit ramps are commonplace throughout campus. More recently built buildings have either incorporated ramps into their architecture and site designs or have avoided the need for ramps by reducing the floor elevation relative to the site. Designers are encouraged to work with their project teams to avoid the need for ramps in any new construction.

Sloped walks are an alternative to ramps where grade change is required but horizontal space allows for a more gradual slope along the walkway. Sloped walks are subtly integrated throughout campus.

When ramps are unavoidable in a project, they should be designed and incorporated into the architectural expression of the building through the use of similar materials and detailing.

Occasionally, topography and circulation will dictate the need for ramps in the landscape. In these instances, ramps should be sensitively integrated into the landform and pathway network as to make them the primary route of travel. Avoid the use of retaining walls and instead provide sloped planted areas.

Handrails are required for ramps, and often guardrails or walls will also be necessary. Consider the character of adjacent buildings and landscape when determining the design and materiality of these vertical elements.

SLOPED WALKS

- SLOPE: 2% - 5% maximum
- DIMENSIONS: 4' minimum width by code, 6' minimum width is the campus standard for walks
- FINISH: Ensure surfaces are non-slip
- HANDRAILS: not required

Sloped walks at the Student Union and Design Building are good examples on campus. Note the generous width, as these are able to serve as primary access points and not secondary accessible routes.



Sloped Walk integrated at Old President's House



Sloped walk at Design Building entry

RAMPS

- SLOPE: Refer to ADA code. 5.1% - 8.33% maximum, landings every 2.5' of grade change
- DIMENSIONS: 4' minimum width by code, consider wider where foot traffic is heavy
- FINISH: Ensure surfaces are non-slip
- HANDRAILS: Continuous handrails 34"-38" tall are required. When overall grade change exceeds 30", a 42" tall guardrail or wall is required

Ramps at the Journalism building are integrated in the architecture of the building, with the retaining walls mimicking the brick and cast stone appearance. The retrofit ramp at Wooden Hall uses a similar material approach, but it is carefully located between existing trees and vegetation. Note that in both situations, the guard portion of the railing could maintain a consistent slope instead of stepping with the ramp and handrail elevations.

Ramps at Life Sciences and Tureaud Hall, both likely retrofit applications, could be better integrated into the building or site design to minimize circulation conflicts and extraneous railings.



Journalism Building ramp integrated into architecture



Wooden Hall retrofit ramp avoids existing trees

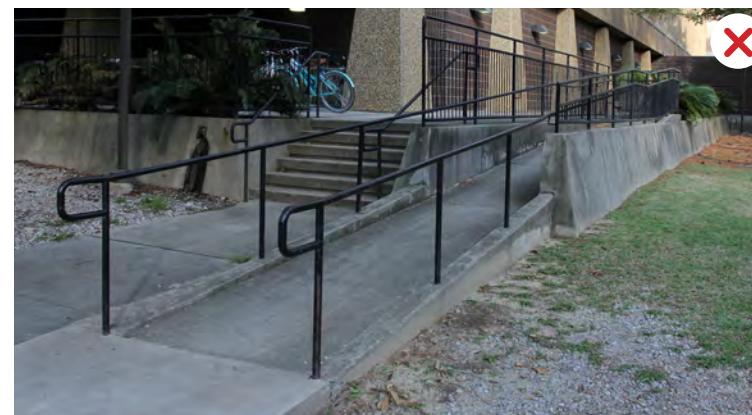

Life Sciences ramp conflicts with primary circulation route



Tureaud Hall ramp lacks the appropriate slope & handrails



3.4 TOPOGRAPHY

STAIRS & RAILINGS

DESIGN RATIONALE

Stairs are the most common tool for navigating grade change on the LSU campus. Many historic buildings on campus were designed with elevated ground floors and ‘garden level’ basements, necessitating the need for stairs to access both levels from the landscape. While new construction projects should avoid this design approach because it creates challenges for universal accessibility, the need for appropriately designed stairs on campus remains.

The general rule for exterior step proportions are 6” risers and 14” treads. This can be modified to fit each situation, however risers should never exceed 7” and treads should never be less than 11”.

RAILING DESIGN RATIONALE

Railings are required at virtually all instances of stairs on campus. Where stairs are integral to buildings, they may be integrated into appropriately designed architectural or freestanding walls, but the railings themselves should also reflect the adjacent architectural character. The standard color for railings is black coated, however other finishes such as stainless steel or hardwood may be considered where the architectural style is complimentary and with approval by LSU. The frequency and profile of railings should follow all ADA requirements for the types of stairs in consideration. Monumental stairs may only be required to have railings at each side of the stair, while stairs at building entrances and along paths may be required to have side and intermittent railings. All designs should be reviewed with LSU to ensure that accessibility and code requirements are met. The example stair photos in this section also represent railing standard styles and styles to avoid.

STAIRS INTEGRAL TO BUILDINGS

Stairs in exterior spaces on campus are often associated with a building entry or door. Where stairs are integral to a building, they should be designed with sensitivity and recognition of the architectural style of the adjacent structure. Provide sufficient landing space outside of building doors and at the bottom of stairs to accommodate significant circulation pressures during high-traffic times of day.



Stairs integrated into architectural walls



Stairs & railings reflective of the adjacent architecture



Retrofit stairs with materials matching adj. building



Building stairs with unnecessary railings and walls

STAIRS IN THE LANDSCAPE

Stairs in the landscape are typically found in two forms: as part of a path, and as monumental stairs in plazas and other large paved areas. Stairs along pathways should be carefully integrated into expressions of landform. Minimize the use of cheek walls and match ratios of riser and tread dimensions to landform slopes. Low groundcovers on either side of stairs further embed stairs into the landscape design.

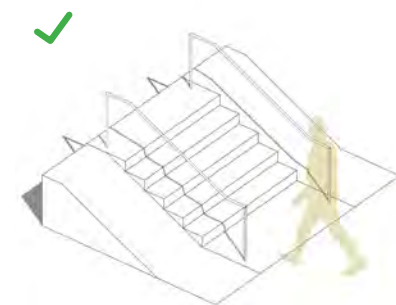
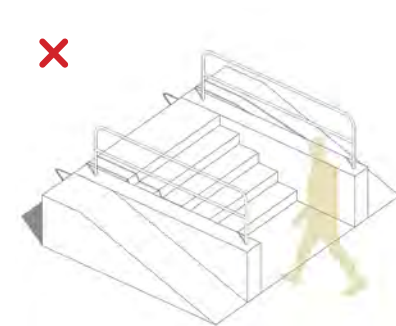

Stairs with unnecessary walls and ornamentation

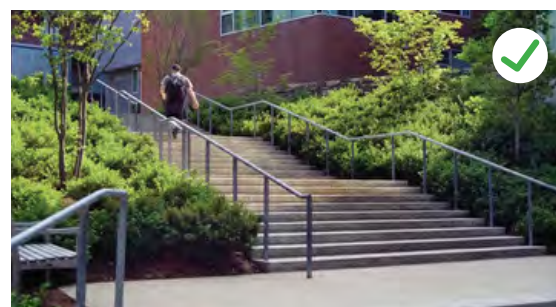

Stairs carefully integrated into topography and planting

MONUMENTAL STAIRS

Monumental stairs are long runs of steps that are usually more gradual in their rise and generous in their tread depths. Monumental stairs double as seating in gathering spaces and do not have the same railing requirements as other stairs. While monumental stairs are useful for elevating important architectural features and providing flexible circulation through plaza spaces, they should only be used in new campus spaces where an accessible route is integral to the design.

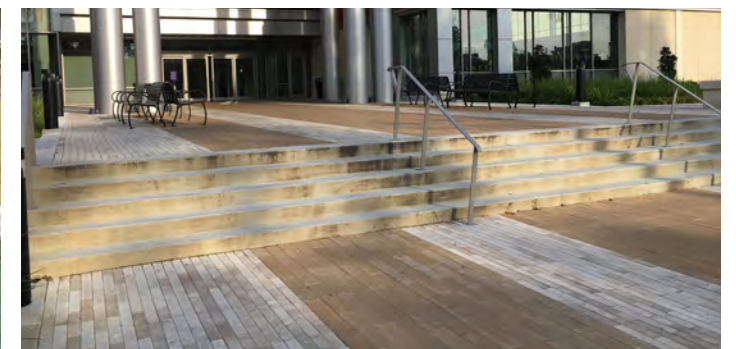
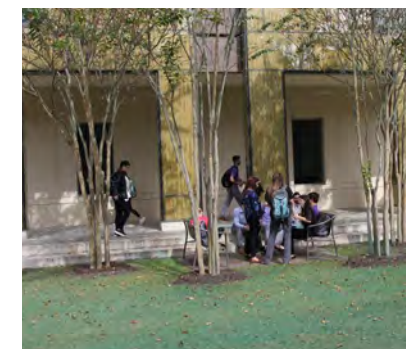

Examples of monumental stairs on campus and elsewhere serving as flexible circulation and seating opportunities

3.4 TOPOGRAPHY

SITE WALLS

DESIGN RATIONALE

Site walls are used selectively on campus to retain grade, as seating elements, or to create a sense of space and enclosure as freestanding walls. Walls, like other built structures in the landscape, should be reflective of the character and style of other adjacent architectural features. Designs and details for walls should always be reviewed with a structural engineer to ensure that they are safely and durably built.

RETAINING WALLS

Retaining walls are most common on campus as elements of a building, used to retain grade around window wells, to serve as wing walls for stairs and ramps, and to form the plinth or foundation of the building. The use of retaining walls as landscape features should be limited to only situations where grade change cannot be mitigated with a slope. Large landscape retaining walls have a tendency to seep moisture through cracks that form over time, degrading the appearance of the wall and undermining its strength. Even when weep holes are used, the resulting runoff water stains adjacent pavement. Where retaining walls must be employed, make efforts to embed them within planting in order to mitigate the issues noted above and to diffuse the scale of the wall.

SEAT WALLS

Seatwalls, whether single walls or stacked amphitheater style, are useful for providing permanent seating in gathering spaces, creating outdoor learning spaces, and providing a vertical edge for garden planting areas. Seat walls should be avoided within spaces that require flexible circulation, however they are useful for framing and defining the edges of these spaces. When walls are stacked to create seats, also provide a stair that allows access to upper levels for those who cannot climb the seatwalls themselves. Seatwalls may be topped with benches or other more refined elements, provided that the overall height of the seat remains usable. In general, the seat portion of the wall should be no shorter than 15” and no taller than 20”; however, this may vary by application.

FREESTANDING WALLS

Freestanding walls are used to define and enclose spaces. They often feature a pillar or column at their ends and intermittent points; however this detail is not required. Walls heights should only exceed 4’-0” in very specific instances and with LSU approval, as this creates the potential for blind spots in the landscape. When a free standing wall is proposed in a design, consideration should always be made for the use of hedges and shrubs that could perform the same screening and enclosing function. Weigh the pros and cons of cost, durability, privacy, and aesthetics when determining if a freestanding wall is the appropriate solution.

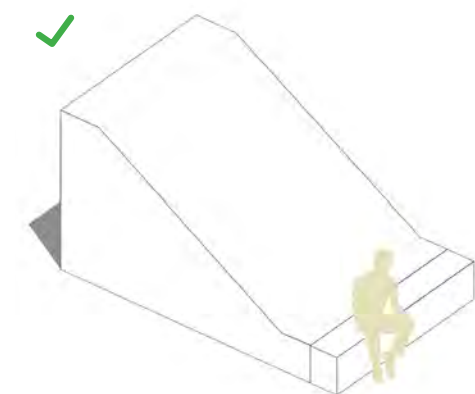
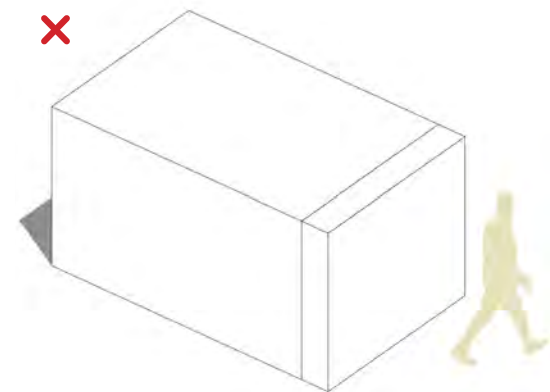

Always consider alternative ways to reduce the height of site walls through the use of slopes or vegetation.



Taller retaining walls over eye level should be avoided



Walls for planting should be used when they can also serve as a form of retaining or seat wall



Good combination of retaining and seat walls

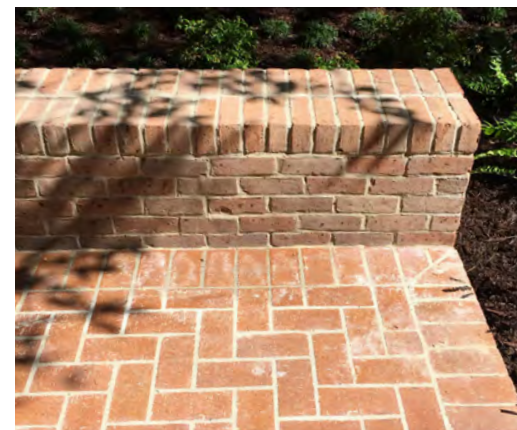

Seat walls in gardens use materials matching the adjacent architecture



Seat walls at the edges of plazas or along paths create gathering spaces



Seat walls may feature other types of seating elements; however, consider overall seat height



Freestanding wall, appropriately embedded in garden, defines the edge of a plaza space



Freestanding walls used to display plaques and memorials may exceed typical heights allowed

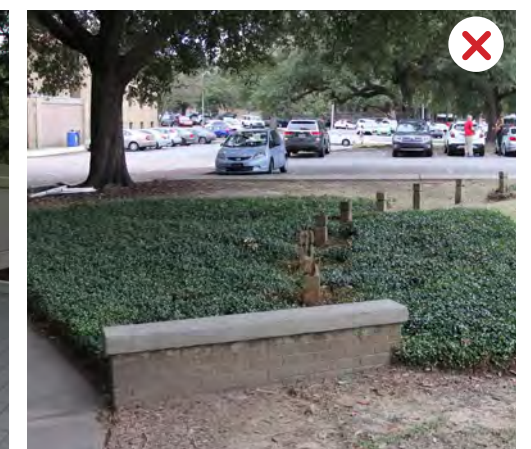

Consider other alternatives when the scale and usability of a wall is uncertain



3.5 WATER

HYDROLOGY

Wedged between the Mississippi River and University Lake, water is as ubiquitous to LSU’s campus as the Live Oaks and terra cotta tile that define its most memorable experiences. With rain totals exceeding 60” annually, storm water management and its implements are a constant presence in the campus landscape. And when it really rains, the impacts can be devastating for infrastructure and resources on campus, as illustrated by the flood event of 2016.

The systems of open space, circulation, and water on campus are intertwined, and designs should proactively embrace opportunities for education and interaction with natural water systems. The Master Plan proposes a framework and tool kit for designers to follow when considering new designs on campus. By providing tools to slow storm water before it enters a management system, identifying areas where excess water may be safely stored, and ensuring key drainage corridors are maintained, the negative impacts of major rain events can be mitigated.

Landscape designers should use these tools as well as their understanding of best-practices to ensure the LSU campus remains resilient and a leader in the goal of living harmoniously with water.



2016 Baton Rouge Flood

DRAINAGE PATTERNS



Mapping of drainage ditches and water bodies from GIS and satellite imagery.

STORM WATER MANAGEMENT FRAMEWORK

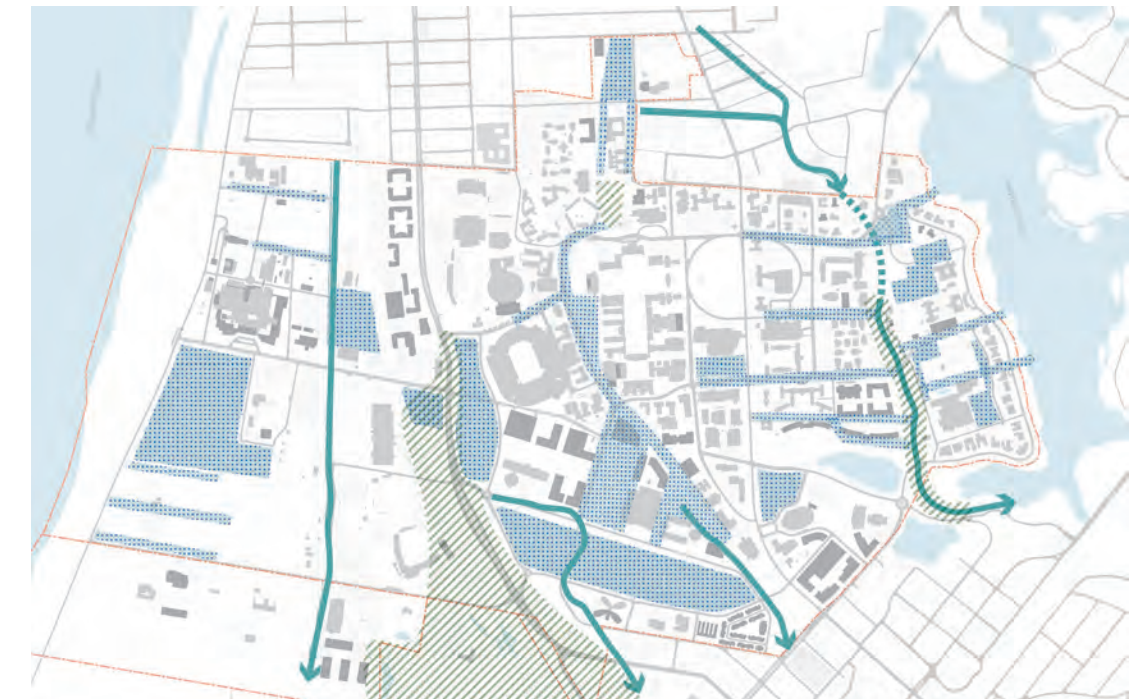

Referenced from campus master plan, courtesy Sherwood Engineers

DESIGNING WITH WATER



The Master Plan vision for Corporation Canal features all three strategies included in the storm water management framework. Native wetland vegetation planting along widened canal banks helps to slow water by creating more opportunities for infiltration and transpiration before entering the canal; broad lawns mid-bank create spaces for storm water to be stored during major events; all while the critical flows and ability to drain water from across the watershed are maintained.

3.5 WATER

STORM WATER COLLECTION

DESIGN RATIONALE

Capture and management of storm water is a major challenge to maintaining the quality, safety, and accessibility of the LSU campus. The intensity of rain events, coupled with the volume of leaf litter generated by Live Oaks and other campus plants, can create situations where drainage structures become overwhelmed and cannot adequately move water away from walkways, roads, and other paved surfaces. Traditional curb, gutter, and screened catch basin systems are the most effective tool for managing storm water. However, alternative systems of trench drains, infiltration drains, and landscaped basins can help the University achieve master plan goals of slowing and storing a greater percentage of the water that falls on campus. Site and landscape designs should consider a combination of these approaches to effectively manage storm water while maintaining the aesthetic and functional needs of the campus environment.

Catch basins, typically designed and located by a civil engineer in coordination with the project landscape architect, are the baseline standard for stormwater capture on campus. Designers should make efforts to appropriately locate catch basins and grade sites to minimize their visual and functional impact on landscape spaces. This means pitching lawns and pavement towards planted areas, where catch basins can be screened by low vegetation and do not disrupt the usability of these surfaces. Catch basins should be protected from clogging by covering them with metal grated debris screens. Where catch basins must occur in lawns, consider domed screens in lieu of the typical rectangular screen.

Large lawn areas and edges of parking lots should be designed to retain or slow water runoff; storm drain system around buildings should be separate from the gutter drain system

CATCH BASINS & AREA DRAINS



(Above left) Catch basins located in planted areas should have screen protection from plant litter.



(Above right) Avoid locating catch basins in the center of lawn areas, as they make lawns harder to use.



(Right) Avoid locating catch basins in paved areas. Where basins must be used, extend the paver surface to the basin rim to minimize disruption to the paving design.

TRENCH DRAINS

Trench drains offer an alternative approach to locating drains in paving that maximizes the amount of paved surface area drained while minimizing the amount of warping and quilting of surfaces required by traditional catch basins. Trench drains should include narrow grate openings, regular clean-out chambers, and in areas with particularly significant storm water volumes, should be supplemented by catch basins located in adjacent planted areas.

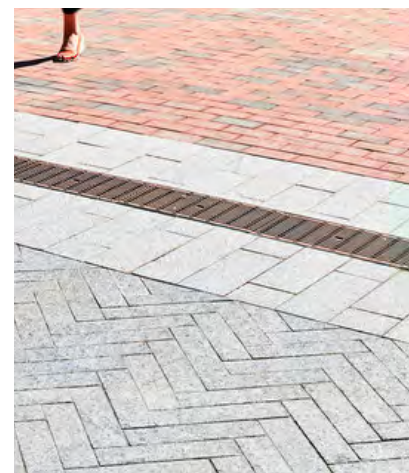
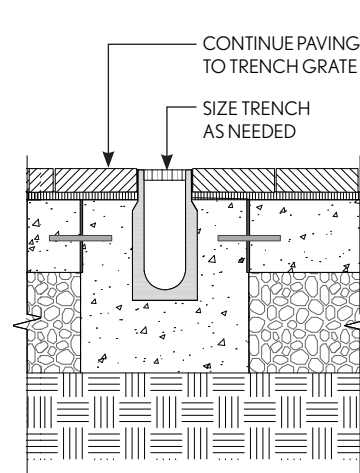

Trench drains at paving edges and supplemented by catch basin

INFILTRATION STRIPS

Infiltration strips or French drains allow storm water to collect and gradually infiltrate into the ground, replenishing ground water and providing an alternate water supply for plants and trees. Like trench drains, frequent cleanout locations and supplement with catch basins should be considered in their use. Infiltration strips are especially effective when used adjacent to buildings, as they also provide a consistent edge for vegetation maintenance.

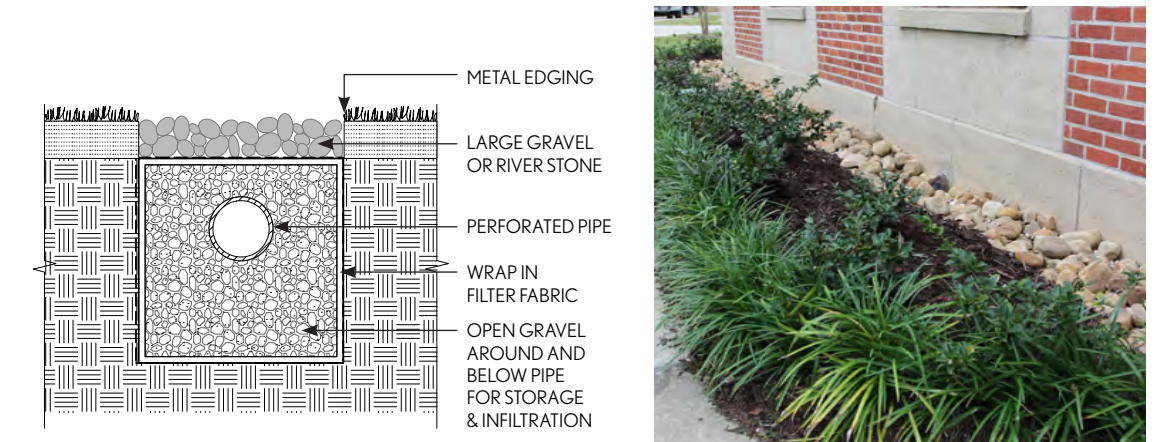

infiltration strip at French House landscape

RAIN GARDENS

Rain gardens and vegetated swales are the best means for slowing and storing water during and after rain events. Louisiana's plant palette is rich with species that will tolerate the extremes of heat, drought, and inundation that characterize the subtropical climate. Their use should be carefully coordinated with adjacent programmatic, circulation, and aesthetic expectations. Rain gardens are especially effective ways to mitigate runoff from parking areas.

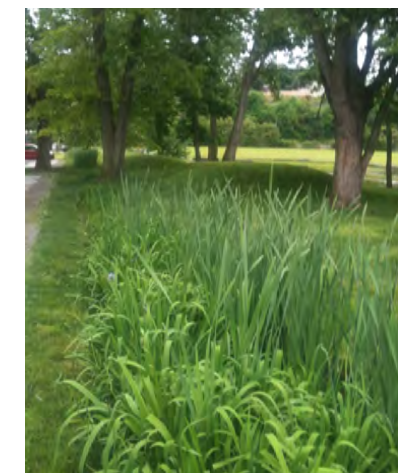

Rain gardens and vegetated swales adjacent to parking areas and pathways



3.5 WATER IRRIGATION

DESIGN RATIONALE

Automatic irrigation is necessary to establish new plantings and to keep existing landscape in a healthy growing condition. Irrigation must be provided to landscape beds where indicated in the Typologies chapter and may be required for high-profile turf areas and major tree plantings. An Irrigation Plan shall be included for all major construction projects, including locating sleeves as required on the site plan.

Proposed irrigation systems shall be designed as “Turn-Key” and include all parts and incidentals. LSU approved back-flow sized for system and including a Netafim water meter and Toro Sentinel Controller shall be included. All control valves shall include an isolation valve and be set in a valve box cover large enough to accommodate both. Quick couplers should be located to allow for supplemental hand watering and to provide water for building and paving washing where necessary. Toro, Hunter, and Rainbird components may be utilized as long as components are compatible with Toro Sentinel Controllers.

When possible, lateral lines should be sized to 1” for ease of future in-house repair. 3M Direct Bury Kits shall be utilized for all low voltage wire connections. Matched precipitation heads are encouraged. Drip irrigation is discouraged due to damage caused by squirrels. Where drip irrigation is used, provide a popup rotor head at the end of zones for easy identification of damage.

Irrigation trenches beneath mature Live Oaks is not permitted. When irrigation is necessary beneath Live Oaks, the contractor shall transition the pipe from the depth specified towards the surface while maintaining 2” minimum coverage. All excavation within the root zone of live oak to be performed by air spade.

LSU Landscape Services maintains the irrigation system for the campus and is in the process of implementing an intelligent, automatic water management system or Master Controller. Toro Sentinel system is the preferred Master Controller and all new irrigation systems shall be compatible and connected to the MC. Small irrigation systems may use an approved wireless controller. This device must be reviewed and approved by LSU PD&C and IT departments. In addition to Toro systems, Hunter Centralus, ICC2, or Hydrowise controllers may be used with approval.

GENERAL IRRIGATION LAYOUT PARAMETERS

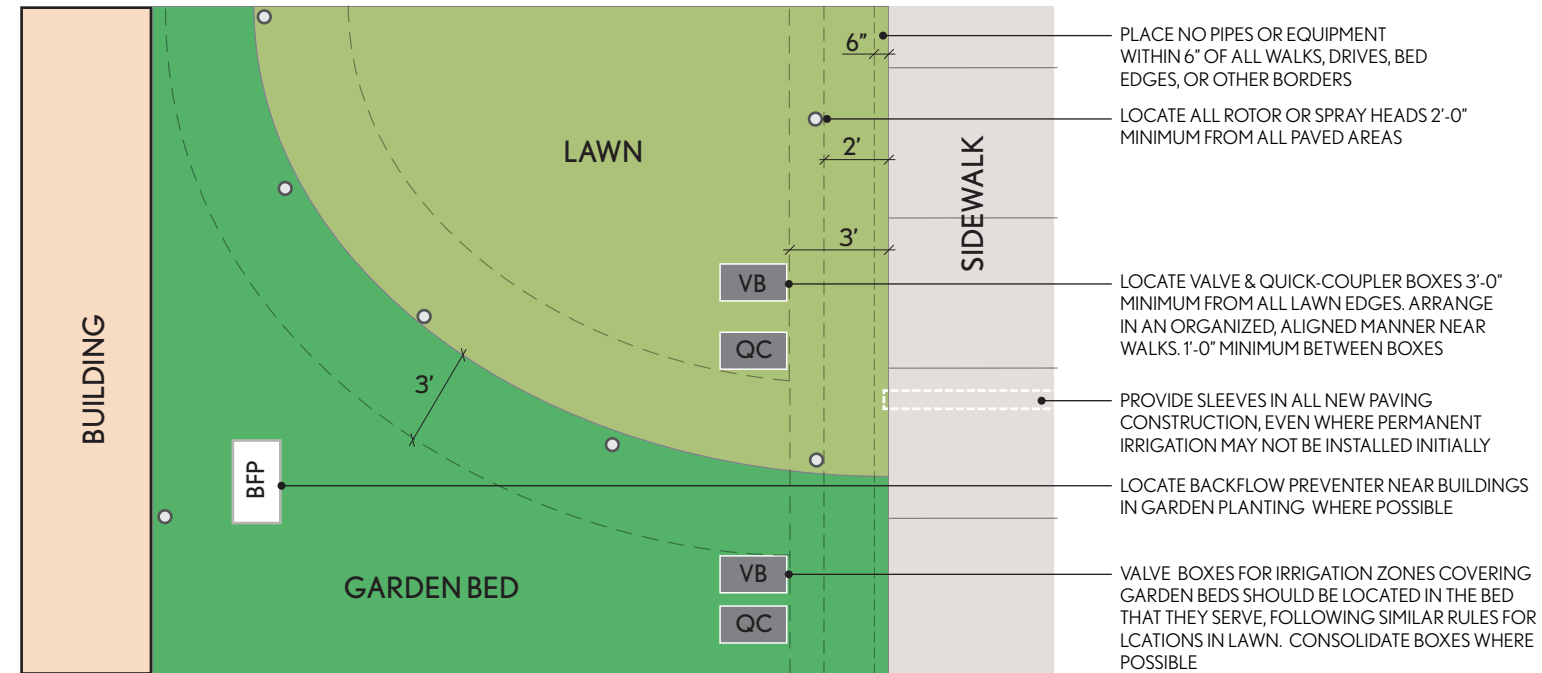

- VB - VALVE BOXES
- QC - QUICK COUPLER - 200' BETWEEN MAX
- BFP - BACKFLOW PREVENTER

TYPICAL IRRIGATION DETAILS

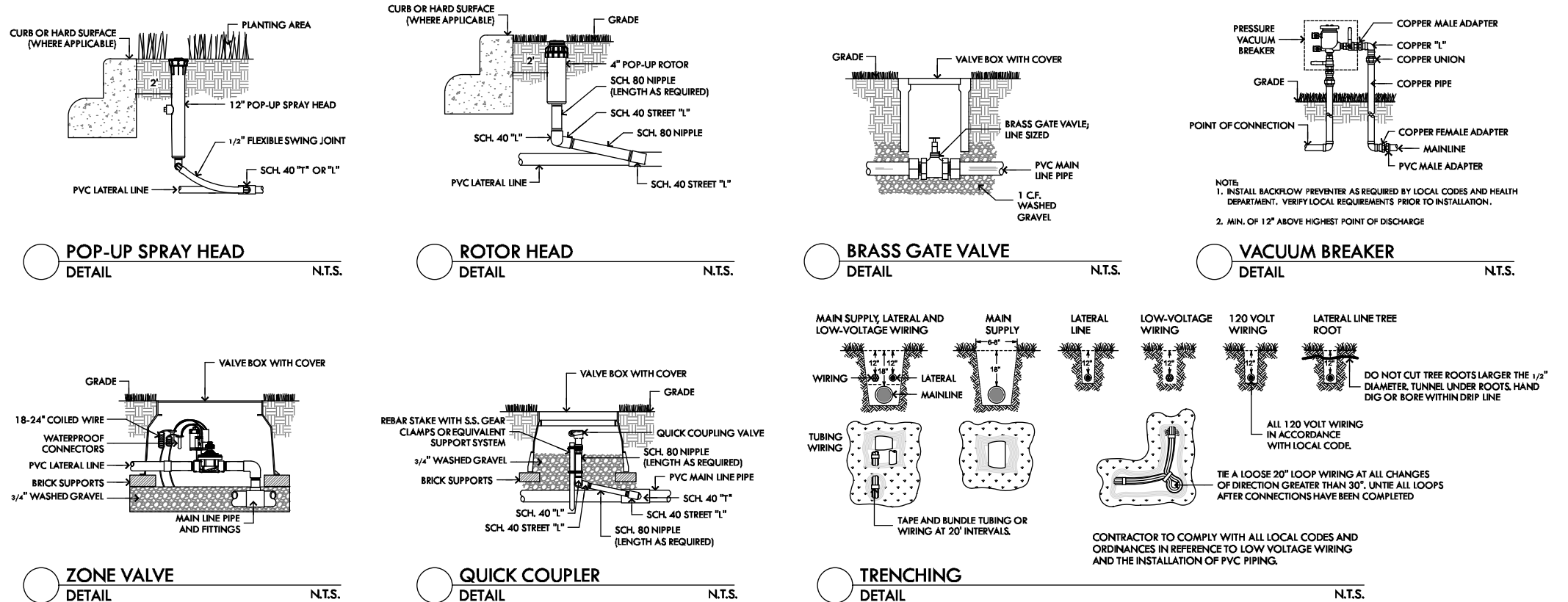

Details are included for reference only. All elements of irrigation systems must be designed and engineered to meet the performance expectations of the project and approved by LSU



3.6 CANOPY LIVE OAKS

DESIGN RATIONALE FOR EXISTING TREES

Live Oaks are the dominant canopy tree on campus and are the backbone of the landscape. There are roughly 1,200 Live Oak trees on campus with an estimated value of over \$50 million.

Many of the existing Live Oaks on LSU’s campus are endowed by benefactors through the LSU Live Oak Endowment Program. The funds raised by the program are dedicated towards Live Oak maintenance such as pruning, bracing, and lightning protection.

Much of campus life occurs in the space and shade below the Live Oak canopy. Considerations for treatment of the ground plane below Live Oaks are influenced by program and circulation needs, as well as aesthetic priorities. Live Oaks play a major role in the layering of landscape and enhancement of architecture discussed in the design principles and objectives in Chapter 1 of this document.

CONSTRUCTION REQUIREMENTS

When working near existing Live oaks, extreme care and special construction methods may be required within the drip line, and in some cases beyond existing Live Oak canopies, to ensure trees are not injured during construction.

When construction occurs around an existing live oak tree, hard fencing along the drip line is required. Cutting or pruning of roots and limbs is not allowed without prior approval from LSU Landscape Services. No parking, staging, or excavating is allowed under drip line of Live Oak trees. Designers shall ensure that adequate controls and protections are included in contract documents.

GROUNDPLANE OPTIONS

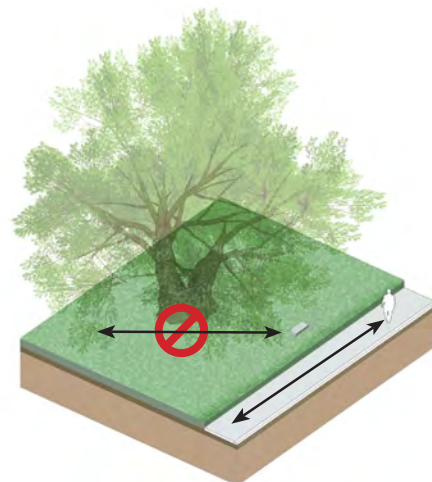
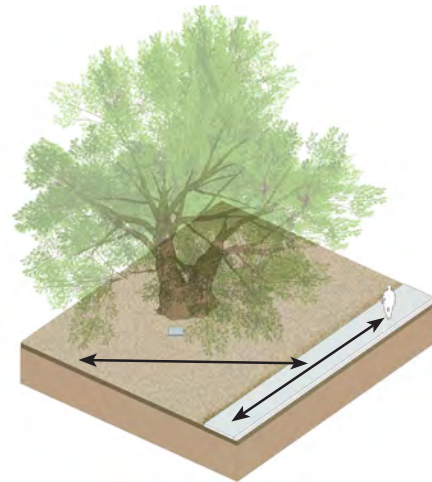

MULCH

Mulch should be used in high-traffic areas where activity and movement are expected beneath the tree as a low maintenance solution. Add mulch to 4” depth extending to dripline where possible. Keep root flare exposed. Identify manhole and utility valves and keep them exposed after mulching.

- Example Areas:
- Parade Grounds
 - Pedestrian Mall
 - Tailgate Areas



Mulch, leaf debris, and minimal pathways below oaks in the sculpture quad

GROUNDCOVER

Groundcover should be used to control traffic near classroom buildings and to discourage jaywalking between sidewalks and roads. It is a moderate maintenance solution.

- Example Areas:
- South Campus at Tower Dr.
 - Adjacent Indian Mounds



Groundcover, pathways, and parking below oaks near the Indian Mounds

GARDEN

Gardens also control traffic and should be used in areas to create a focal point and attract attention. It is a high maintenance solution.

- Example Areas:
- Quad
 - Building Frontages
 - Along Highland Road



Groundcover and low shrubs below Live Oaks in the main quad

DESIGN RATIONALE FOR NEW TREES

When planting new campus streets and grounds, consideration must be first given to the Live Oak and its role in preserving the historic tree canopy structure of the campus. For new streetscape plantings, cloned cultivars such as ‘Cathedral’ with a more pyramidal upright habit may be employed to mitigate conflicts with city buses and lighting. Another Live Oak variety that may be employed for even more restrictive spaces is the ‘Highrise’ Live Oak which is the most columnar of the LSU accepted varieties.

Consideration must also be given to the arrangement of Live Oak plantings. The original live oak plantings of the 30s and 40s primarily took the approach of creating formal allees along roads and in quad spaces. Later plantings of live oaks in the Memorial Grove and in lowland areas of pasture and golf course took a more informal approach, arranging the trees in dense irregular groves. These forms, especially in areas where the campus is growing, should be taken into account when siting new buildings and designing landscapes around them. In general, no new “orchards” of live oaks should be planted on campus, and proposed tree species and locations should be reviewed with LSU.

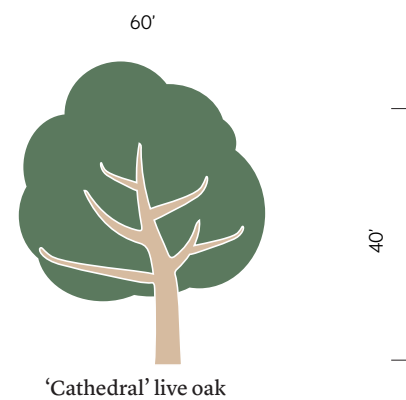
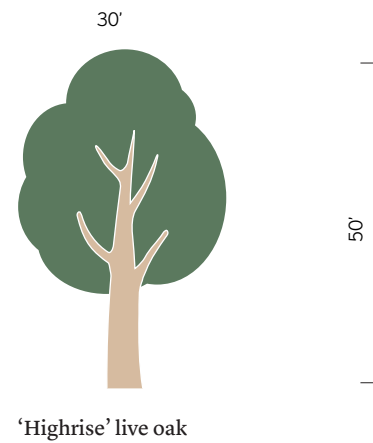
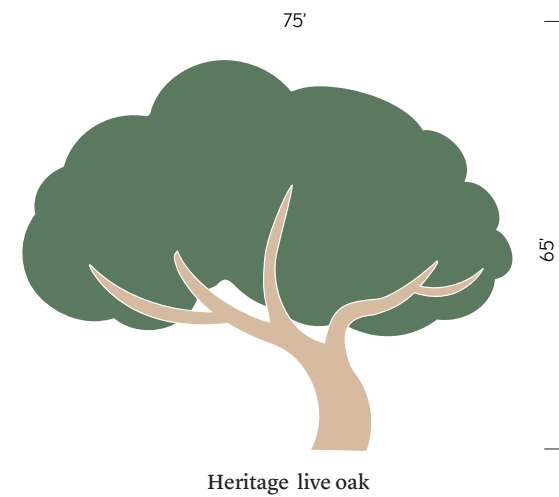

FORMAL ALLÉE

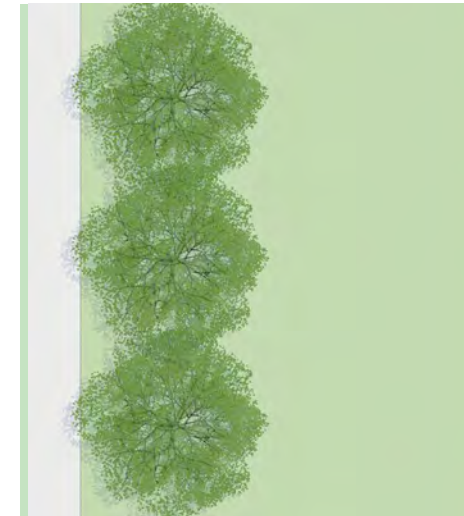

Formal allees of Live Oaks should only be planted where they are matching or replacing existing allees. Live oak allees are excellent tools for shading sidewalks and roads. Review plans for new tree allees with LSU.

GROVE GROUPING



Informal groves of live oaks are most common in the vast spaces of the campus lowland. They may be interspersed with other canopy trees for more diversity. They also make great places for locating pockets of program such as seating areas and other gathering spaces



3.6 CANOPY

CANOPY & EVERGREEN TREES

DESIGN RATIONALE

While Live Oaks will continue to provide a pervasive canopy across the campus, the campus is greatly improved when the tree canopy is diverse and vibrant. Many species of trees, both native and adapted, are excellent choices for planting in renovations and new landscape projects. Creating shade on walks, plazas, courtyards, and other primary circulation and gathering spaces is a primary objective of any landscape design. Tree canopy brings a sense of human scale to spaces, especially where buildings are growing larger in footprint and height.

Choosing the right tree for a landscape requires determining the intent for the use of spaces below and around the trees as well as the aesthetic and scale values provided. Some trees are more suited for defining the edges of spaces, and others create space below their canopies for programming and activity. Tree species with consistent form can be used to line walks and drives where regularity is desired. Blends of tree species, forms, and textures create park-like settings and offer diversity for wildlife.

CONSTRUCTION REQUIREMENTS

When construction occurs around an existing tree, hard fencing along the drip line is required. Cutting or pruning of roots and limbs is not allowed without prior approval from LSU Landscape Services. No parking, staging, or excavating is allowed under drip line of any trees.

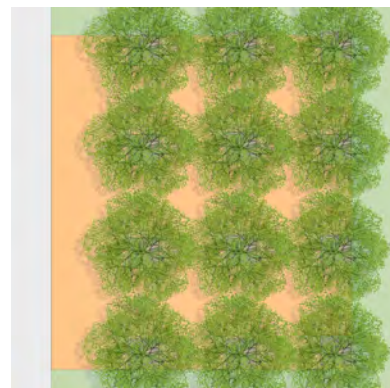
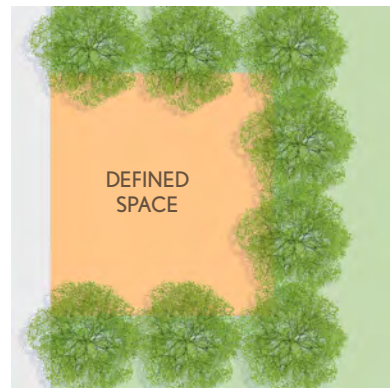
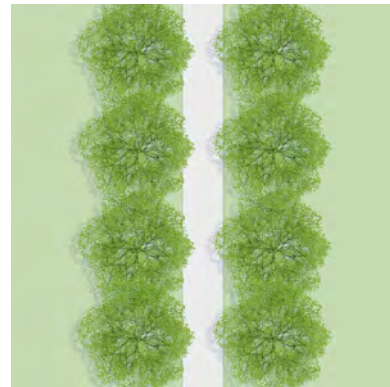

ARRANGEMENT OPTIONS

SHADING WALKS & PARKING LOTS

Rows of densely planted trees will provide ample shade for large paving surfaces. Use trees with upright forms to prevent conflicts with vehicular traffic. Some areas of parking lots may take advantage of trees and swales for storm water management.



Well-shaded parking lots

DEFINING & ENCLOSING SPACES

Trees may be used to delineate and create an edge around spaces. Live Oaks are especially good for enclosing large spaces because of their low, wide form.



Live Oaks enclosing the Parade Grounds

PLANTING IN LARGE OPEN SPACES

Park-like tree plantings may include diversity of species for interesting texture and form compositions. Pathways and programs can take place below and around trees.



Mix of canopy trees in the quad

CREATING SPACE BELOW CANOPY

Upright trees planted in paved spaces can create a ceiling for plazas and courtyards, bringing a human scale and shade to otherwise hot and hard spaces.



Trees planted in paving

COMMON NAME	SCIENTIFIC NAME	PLANT SIZE (H x W)	SUNLIGHT	SOIL	FLOWERING/ FOLIAGE	USES / COMMENT
Italian Cypress	Cupressus sempervirens	H 115'	full	dry	Evergreen	Difficult to fit into residential landscapes. Good specimen around tall buildings.
Japanese Blueberry	Elaeocarpus decipiens	50 X 40'	full	well drained	Evergreen	Year-Round Interest, Establishes quickly providing thick, fast shade
Loquat	Eriobotrya japonica	25 x 12'	full	well drained	Evergreen	Plants are grown commercially for fruit production or as landscape ornamentals
Ginkgo	Ginkgo biloba	50 x 30'	full	varies	Deciduous	Bright fall yellow color
Foster Holly	Ilex x attenuata 'Fosteri'	20 X 12'	full	well drained	Evergreen	Ornamental Berries
Nellie Stevens Holly	Ilex x 'Nellie R. Stevens'	20 x 13'	full	adaptabe	Evergreen	Borders, screens, hedges, foundations. Specimen. Small tree.
American Holly	Ilex opaca	40 x 30'	full	well drained	Evergreen	Specimen or group. Foliage provides excellent color for the winter landscape
Southern Magnolia	Magnolia grandiflora	40 x 25'	full	moist, acidic	Deciduous	Beautiful specimen flowering tree for lawns.
Sweetbay Magnolia	Magnolia virginiana	30 x 20'	full	moist, acidic	Deciduous	Will grow in wet soils such as those found in low spots or near ponds/streams.
'Australis' Sweet Bay	Magnolia virginiana var. australis	60 x 60'	full	moist	Evergreen	Will grow in wet locations such as low spots or near ponds or streams.
Compact Cherry Laurel	Prunus caroliniana	15 x 20'	full	well drained	Evergreen	It's primary value is as a hedge to provide a solid privacy barrier or windbreak
Chinese Pistachio	Pistacia chinensis	35 x 25'	full	well drained	Deciduous	Brilliant autumn color, long lived tree
Spruce Pine	Pinus glabra	25 x 20'	full	moist, acidic	Evergreen	
Sycamore	Platanus occidentalis	70 x 40'	full	moist	Deciduous	Brown fall color. Grows to a larger trunk diameter than any other native hardwood
Longleaf Pine	Pinus palustris	60 x 30'	full	deep sandy	Evergreen	Very drought-tolerant and require no irrigation for survival, cracking asphalt
Sawtooth Oak	Quercus acutissima	50 x 30'	full	moist, fertile	Deciduous	Shade tree, light gray furrowed bark
Shumard Oak	Quercus shumardii	50 x 40'	full	well drained	Deciduous	Glossy on upper surface. Excellent red autumn color.
Southern Live Oak	Quercus virginiana	50 x 75'	full	moist, fertile	Evergreen	Structural planting in quad, courtyard and along main roads
Bald Cypress	Taxodium distichum	50 x 25'	full	water, acidic	Deciduous	Good selection for growing in wet soils either in low spots or near water.
Pond Cypress	Taxodium ooscendens	20'	full	moist	Deciduous	Likes landlocked bodies of water
Winged Elm	Ulmus alata	80 x 50'	full	sandy	Deciduous	A common street and shade tree
'Princeton' American Elm	Ulmus americana	60 x 40'	full	acidic	Deciduous	Bright red anthers(late winter)

RECOMMENDED TREES FOR:

WET SITES



Bald Cypress

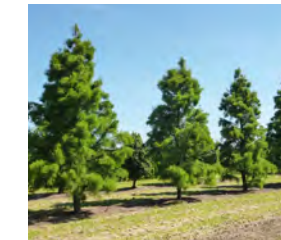

Pond Cypress



'Australis' Sweet Bay

SMALL SPACES



'Little Gem' Magnolia



Loquat



Compact Cherry Laurel

STREET & PARKING



Shumard Oak



'Princeton' American Elm



Ginkgo

OPEN SPACES



Southern Live Oak



Southern Magnolia

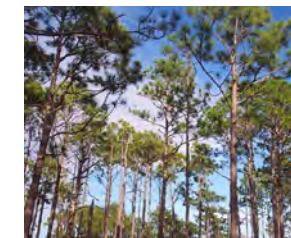

Longleaf Pine

PLAZAS / PAVED SPACES



Sawtooth Oak



Chinese Pistachio



Italian Cypress

* Hickory, White Oak, Willow Oak and Cow Oak are good additional canopy trees.
 * Additional plant material will be considered with prior LSU landscape architect approval.



3.6 CANOPY

ORNAMENTAL & PALM TREES

DESIGN RATIONALE

Ornamental trees that are historically associated with the campus include: Crepe Myrtles and Japanese Magnolias. Some ornamental trees are short lived. A preference for longer lived and maintenance friendly trees is preferred.

Palms have been a part of the campus landscape going back to the original plantings in the 20's and 30's. Palms work well with Italian Renaissance architecture and reinforce the Mediterranean character. Palm tree sizes vary and careful planning should be given when selecting palms. Windmill palms work well in tight spaces. Sago palms are discouraged because they become misshapen as they age and are relatively short lived.

Planting sight-lines should be designed to allow adequate light distribution from light sources, to reduce future maintenance, and create open view corridors between trees and shrubs to decrease hidden spaces that create a sense of uncertainty in the landscape.

CONSTRUCTION REQUIREMENTS

Ornamental trees shall be container grown with a single straight leader or multi-caned (designer shall specify). Palms shall be container grown with a single straight leader. Ornamental trees and palms shall be well rooted and with a shape and habitat consistent with the species. Minimum container size is 30 gal./6' tall at the time of planting. Smaller palms shall be planted in 7 gal. containers.

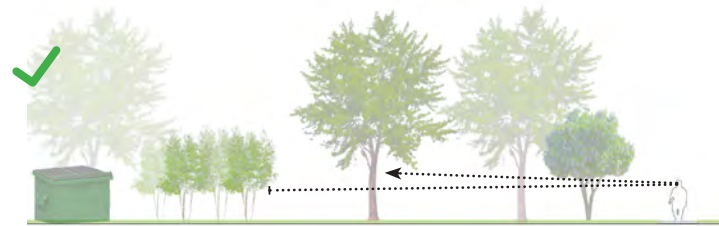

DO

- Use as accent elements.
- Use in areas where minimal shade is desired.
- Use as screening.

DON'T

- Use in lines where a physical or visual relationship can be damaged.
- Use in place of canopy trees in areas that desire more shade.



COURTYARDS



ACCENTS

COMMON NAME	SCIENTIFIC NAME	PLANT SIZE (H x W)	SUNLIGHT	SOIL	FLOWERING/ FOLIAGE	USES / COMMENT
Green Japanese Maple	<i>Acer palmatum</i>	20 x 20'	sun/ shade	well drained	Deciduous	
Japanese Maple	<i>Acer palmatum 'dissectum'</i>	3 x 5'	partial shade	well drained	Deciduous	Often growing as an understory plant in shady woodlands
Pindo Palm	<i>Butia capitata</i>	12 x 10	full	well drained	Palm	Stout, thick trunk with bold foliage sprays from the top. Easy care
'Forest Pansy' Red Bud	<i>Cercis canadensis 'Forest Pansy'</i>	20 x 25'	full	moist	Deciduous	Rosy-pink flowers on bare branches bridge the gap between winter and spring
Red Bud	<i>Circus canadensis</i>	20 x 15'	full	well drained	Deciduous	Showy light to dark magenta pink, clusters (sometimes on trunk)
Kousa Dogwood	<i>Cornus kousa</i>	30 x 30'	full	well drained	Deciduous	Good fall color, bark attractive in winter
Parsley Hawthorn	<i>Crataegus marshallii</i>	20 x 15'	high shade	well drained	Deciduous	Small tree with wide-spreading, Leaves become colorful in fall.
'Diana' Althea	<i>Hibiscus syriacus 'Diana'</i>	8 x 5'	full	well drained	Evergreen	Enjoyment of summer flowers.
'Natchez' Crape Myrtle	<i>Lagerstromia indica 'natchez'</i>	H 15'+	full	well drained	Deciduous	Cinnamon colored bark, leaves turn vibrant orange-red in fall
'Near East' Crape Myrtle	<i>Lagerstromia indica 'near east'</i>	H 15'+	full	well drained	Deciduous	Long lasting clusters of soft pink flowers. bright green in summer, orange-red in fall
'Little Gem' Magnolia	<i>Magnolia grandiflora "Little Gem"</i>	15 x 8'	full	slightly acidic	Evergreen	Effective in lawns, near decks/patios, Also may be grown as a screen or hedge.
Japanese Magnolia	<i>Magnolia liliiflora</i>	10 x 8'	full	well drained	Palm	Blooms profusely in early spring with large pink to purple showy flowers
'Yellow Bird' Magnolia	<i>Magnolia 'Yellow Bird'</i>	40 x 30'	full	well drained	Deciduous	Yellow flowers, can be used to stand it apart from other plants with finer foliage
Sweet Bay Magnolia	<i>Magnolia virginiana</i>	30 x 20'	full	moist, acidic	Deciduous	Excellent choice near patios, wood edges, and shrub borders, also tolerant to wet site
Canary Island Date Palm	<i>Pheonix canariensis</i>	20 x 15'	full	well drained	Palm	Growing speed is slow
Needle Palm	<i>Rhapidophyllum hystrix</i>	H 8'	partial shade	sandy	Palm	Low maintenance
Dwarf Palmetto	<i>Sabal minor</i>	9 x 7'	shade	wet swampy	Evergreen	Plant forms a trunk when grown in standing water.
Cabbage Palm	<i>Sabal palmetto</i>	60 x 10'	full	sandy	Palm	Tolerate a wide variety of soil and weather conditions.
Saw Palmetto	<i>Serenoa repens</i>	3 x 3'	sun/ shade	moist	Palm	Difficult to move. Position plants away from place where the saw might cause harm.
Windmill Palm	<i>Trachycarpus fortunei</i>	15 x 5'	full	sandy, loam	Palm	It tolerates cool, moist summers as well as cold winters
'Shoals Creek' Vitex	<i>Vitex agnus-castus 'Shoal Creek'</i>	15 x 12'	full	well drained	Perennial	Interesting foliage and late summer flowers. Shrub borders, foundations, cottage gardens or butterfly gardens.
Washingtonia Palm	<i>Washingtonia robusta</i>	60 x 80'	full	sandy	Palm	Grow fast, No two grow at the same pace, so pairs of these palms are not a good choice for symmetrical landscape

RECOMMENDED TREES FOR:

WET SITES



Dwarf Palmetto



Saw Palmetto

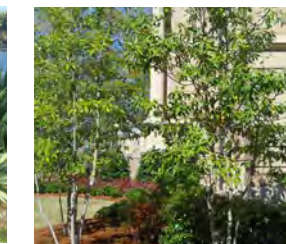

Sweetbay Magnolia

SMALL SPACES



'Natchez' Crape Myrtle

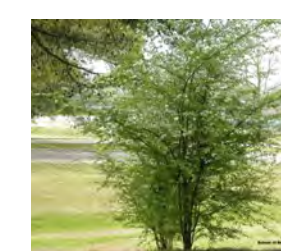

Parsley Hawthorn



Japanese Maple

FLOWERING INTEREST



'Yellow Bird' Magnolia

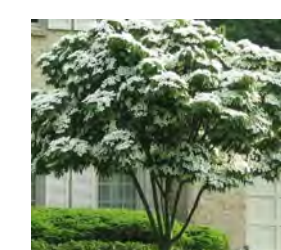

Kousa Dogwood



'Shoals Creek' Vitex

PALMS



Windmill Palm



Cabbage Palm



Pindo Palm



Canary Island Date Palm



Washingtonia Palm



Dwarf Palmetto

* Queen Palms and Medjool Date Palms are not allowed.

* Additional plant material will be considered with prior LSU landscape architect approval.



3.7 GARDEN GARDENS

DESIGN RATIONALE

Gardens on campus are expressive of a vibrant plant palette, consisting of a combination of native and adapted plants. While gardens can be an effective way to break down scale, creating more intimate entry & gathering spaces throughout the campus, they should be implemented with restraint as they require special care and additional maintenance.

Groundcovers are the primary garden element on campus, filling spaces around buildings, below trees, and between shrubs and other plantings. Groundcovers that have done historically well on campus include: Liriope, Asian Jasmine, Mondo, and Cast Iron Plant. Liriope plantings on campus have recently have been subject to root rot and other fungus issues. The cultivar ‘Super Blue’ Liriope has shown to be resistant to root rot and therefore should be specified for Liriope planting. Asian Jasmine is also prevalent on campus. Under certain circumstances it does very well, however, it should never be used in combination with other plantings. Groundcovers that perform well in deep shade include: Mondo, Dwarf Mondo, Dwarf Yew, Cast Iron Plant, and Ferns.

Perennials bring seasonal interest and contrast to garden plantings; however, they are higher maintenance plantings and should be reserved for higher profile locations. Perennials that have historically done well on campus include: Indigo, Butterfly Iris, and Agapanthus. Perennials that bloom purple and gold have the added benefit of reinforcing the LSU brand. Perennials that are award winning cultivars with superior toughness are preferred over common varieties. Refer to LSU Ag recommended “Super Plants”.

Shrubs provide structure and scale to campus landscape spaces. Avoid busy combinations of plantings and aim for the majority of shrubs to be evergreen. Shrubs that have historically performed well on campus include: Carissa Holly, Shi Shi Gashira Camellia, and Cleyera. Cultivars of Shrubs with superior toughness and smaller in stature are preferred.

CONSTRUCTION REQUIREMENTS

All shall be container grown, well rooted, and with a shape and habit consistent with the species. Minimum container size for perennials and groundcovers is 1 gal./12” tall at the time of planting. Minimum container size for shrubs is 3 gal.

GARDEN DESIGN CONSIDERATIONS



DO

- Design with a low growing evergreen edge.
- Use to add variation of plants to create interest.
- Manage heights of plants to allow views across the garden.
- Use perennials that bloom purple or gold when possible.
- Arrange plants in large masses of the same species to simplify maintenance.



DON'T

- Plant a high growing edge that will block views.
- Intermix species requiring different levels of light and water
- Design gardens in areas that can't receive needed maintenance.

SEASONAL PLANTING

Annual plantings may be used to add seasonal color and interest to garden beds. They should be used sparingly and with careful consideration of maintenance and cost factors.



GARDEN LAYERING

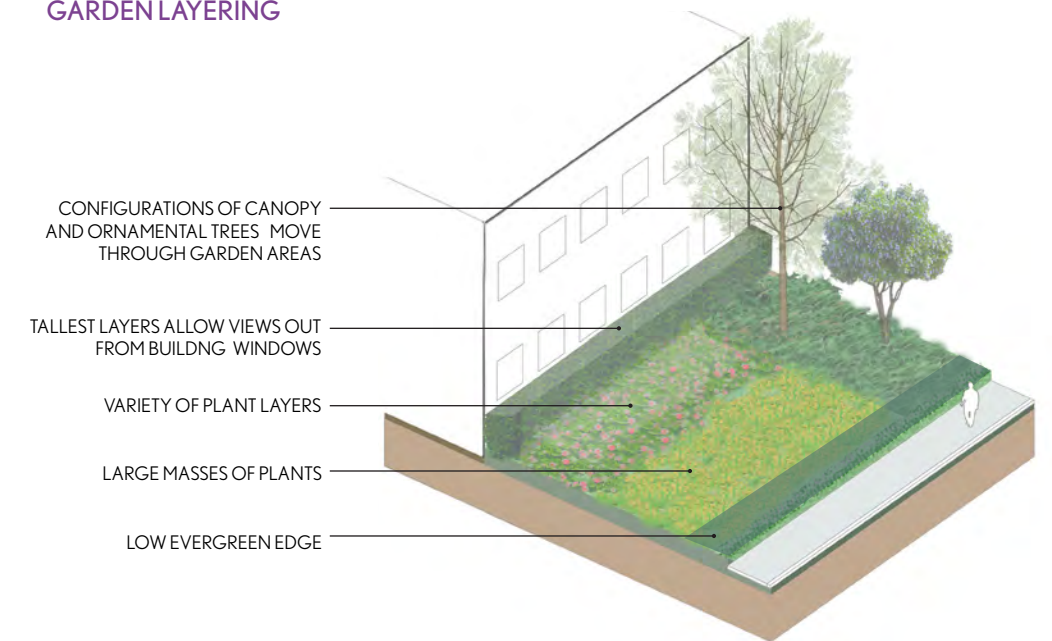

Examples of well-layered garden planting.

GARDEN - SHRUBS, GROUND COVER, PERENNIALS

COMMON NAME	SCIENTIFIC NAME	PLANT SIZE (H x W)	SUNLIGHT	SOIL	FLOWERING/ FOLIAGE	USES / COMMENT
Ardesia	Ardisia crenata	3 x 2'	full	moist	Perennial	Small white or reddish flower, fragrant and form clusters. The fruit is a bright red drupe.
Asparagus Fern	Asparagus densiflorus	3 x 4'	partial shade	well drained	Fern	Green stems are valued by florists for adding to flower arrangements.
Fox Tail Fern	Asparagus densiflorus 'Myersii'	3 x 4'	partial shade	well drained	Perennial	Forms an interesting ground cover.
Cast Iron Plant	Aspidistra elatior	18 - 30'	shade	pourous	Perennial	Radial, rugged, dark green leaf Low maintenance
'Ellamae' Agapanthus	Agapanthus x 'Ellamae'	4 x 3'	full	well drained	Perennial	Semi-Evergreen, purple flower
Glossy Abelia	Abelia x grandiflora	6 x 6'	sun- part shade	well drained	Deciduous	reliable flowering shrub, pinkish white flowers
Boxwood	Buxus sp.	varies, 3 x 2' avg	full	well drained	Evergreen	dense foliage, makes great hedges. Many cultivars available
'Blue Chip' Buddleia	Buddleja 'Blue Chip'	2 x 2'	full	well drained	Deciduous	Provides attractive summer to early fall flowers when few other shrubs are in bloom.
'Buzz' Purple Buddleia	Buddleia davidii	4 x 4'	full	well drained	Deciduous	Purple flower, use as a semi-green blooming hedge in warmer climates.
Mulberry	Callicarpa americana	6 x 6'	full	acidic	Deciduous	The plant itself has a sprawling habit, Food for wildlife
Shishi Gashira Camellia	Camellia hiemalis 'Shishigashira'	4 x 4'	adaptable	acidic	Evergreen	A profusion of hot pink, with golden yellow centers and glossy, dark green foliage.
'Little John' Bottlebrush	Callistemon rigidus 'little john'	3 x 4'	full	well drained	Evergreen	Blood red, bottlebrush-like flower spikes cover from spring into summer.
Ruby Spice	Clethra alnifolia 'Ruby Spice'	6 x 5'	full	Medium to wet	Deciduous	Bloom in shady locations in late summer
'Sixteen Candles' Clethra	Clethra alnifolia 'Sixteen Candles'	3 x 4'	partial shade	well drained	Deciduous	Fragrant white flower spikes attract butterflies.
'Fritz Huber Dwarf Yew	Cephalotaxus harringtonia 'Fastigiata'	10 x 8'	partial shade	well drained	Conifer	Low, compact habit, Spreading
Dwarf Plumbago	Ceratostigma plumbaginoides	10 x 24'	partial shade	well drained	Perennial	Electric blue flowers , Multi-Season Interest
Holly Fern	Cyrtomium falcatum	2 x 3'	partial shade	well drained	Fern	Woodland and shaded areas of borders or rock gardens. Border for tree or shrub.
Variegated Dianella	Dianella tasmanica 'Variegata'	3 x 1'	full / partial shade	well drained	Perennial	Bright Foliage for Light Shade
Butterfly Iris	Dietes grandiflora	4 x 3'	full	moist	Evergreen	Used for massing in commercial landscapes too dry or too sunny for lilyturf and liriopie.
Evergreen Witch Hazel	Distylium racemosum	6 x 6'	full	well drained	Evergreen	slow growing, red flowers
'Green Spire' Euonomous	Euonymus japonicus 'Green Spire'	8 x 12'	partial shade	well drained	Evergreen	Easy Care Hedge Plant, inconspicuous; prized for foliage.
'Tutti Fruitti Pink' Buddleia	Flutterby Petite Tutti Fruitti Pink Buddleias	3 x 3'	full	well drained	Deciduous	A wonderful purple color to any landscape and attracting butterflies during the warm season
Frost-Proof Gardenia	Gardenia jasminoides 'frost proof'	5 x 8'	full	well drained	Evergreen	Shiny leaves and fragrant blooms that can be smelled from a distance.

RECOMMENDED PLANTS FOR:

WET SITES

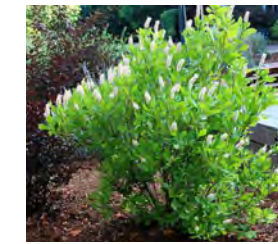

Ruby Spice



'Jeri' LA Iris



Sword Fern

SHADE

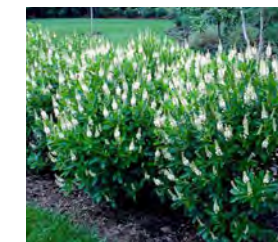

'Sixteen Candles' Clethra



'Conversation Piece' Azalea



Oakleaf Hydrangea



Dwarf Plumbago



'Henry Garnet' Itea



Variegated Dianella

FLOWERING INTEREST

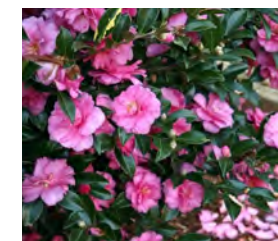

Shishi Gashira Camellia

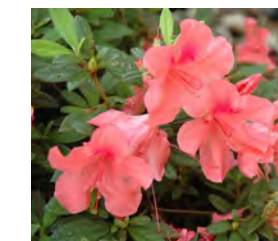

Encore Azaleas



Frost-Proof Gardenia



Julia Child' Rose



'Ellamae' Agapanthus



'Tutti Fruitti Pink' Buddleia



'Penny Mac' Hydrangea	Hydrangea macrophylla	6 x 4'	partial shade	acidic	Deciduous	fantastic mophead flowers repeatedly throughout summer
'Buttered Popcorn' Daylily	Hemerocallis 'Buttered Popcorn'	3 x 3'	full	adaptable	Perennial	Easy grow and care
Oakleaf Hydrangea	Hydrangea quercifolia	6 x 4'	partial shade	well drained	Deciduous	Can grow very well in drier soil, but it cannot tolerate "wet feet."
Indigo	Indigofera kirilowii	2 x 2'	partial shade	moist	Deciduous	Under large trees for an attractive and colorful ground cover. Semi-evergreen in warmer climates
Carissa Holly	Ilex cornuta 'Carissa'	H 3'	full	well drained	Evergreen	Drought and heat tolerant; excellent formal shrub.
Dwarf Yaupon	Ilex vomitoria 'nana'	2' x 2'	full	varied	Evergreen	Primarily grown for its highly ornamental fruit
'Black Gamecock' Iris	Iris louisiana 'Black Gamecock'	3 x 0.5'	full	well drained	Perennial	Deep purple to black blooms and flaunt their unique form wherever they are planted.
'Henry Garnet' Itea	Itea virginica 'Henry's Garnet'	4 x 6'	partial shade	well drained	Deciduous	A good selection for wet locations such as low spots or pond/stream margins
'Jeri' LA Iris	Jeri Louisiana Iris	3 x 1.5'	full	moist	Perennial	Velvety dark grape violet
'New Gold' Lantana	Lantana x 'New Gold'	1 x 2'	full	well drained	Evergreen	Evergreen in warm, frost-free climates; treat as a summer annual in northern regions
'Super Blue' Liriope	Liriope muscari 'Super Blue'	2 x 1.5'	partial shade	well drained	Evergreen	Striking violet-blue flower spikes, taller and showier
Loropetalum	Loropetalum chinense 'Burgundy'	8 x 5'	full	well drained	Everpurple	Ragrant, spidery flowers in late winter and early spring.
Adagio Maiden Grass	Miscanthus sinensis 'Adagio'	4 x 4'	full	well drained	Herbaceous	Showy Dwarf Grass, visual interest in winter
'White Cloud' Muhly Grass	Muhlenbergia capillaris	H 4'	full	adaptable	Herbaceous	Dramatic Foliage Color, North American Native Selection, Waterwise
Gulf Muhly	Muhlenbergia capillaris 'Lenca'	4 x 3'	full	well drained	Herbaceous	Showy Pink Plumes, Thrives with regular water, but tolerates periodic drought.
'Don'sDwarf' Wax Myrtle	Myrica cerifera	10 x 8'	partial shade	moist	Evergreen	Its leaves are fragrant when crushed and are an olive green color. Tolerance
Cassian Fountain Grass	Pennisetum alopecuroides 'Cassian's Choice'	2 x 2'	full	average	Herbaceous	Also grows well in moist locations such as peripheries of water gardens, ponds or streams.
Mondo	Ophiopogon japonicus	H 1'	partial shade	well drained	Evergreen	Grow well under shade
Dwarf Mondo	Ophiopogon japonicus 'Nanus'	0.5' x 1'	partial shade	well drained	Evergreen	Ornamental grass-like ground cover for shady areas of the landscape
Sword Fern	Polystichum munitum	6 x 6'	shade	well drained	Fern	Lush Foliage for Shade
Encore Azaleas	Rhododendron Encore	3 x 3'	full	acidic	Evergreen	
'Conversation Piece' Azalea	Rhododendron x 'Conversation Piece'	3 x 3'	partial shade	moist	Evergreen	Isn't bothered by pests, disease, deer. It's even drought resistant
Julia Child' Rose	Rosa hybrid 'Wekvossutono'	3 x 3'	full	adaptable	Deciduous	Bloom continuously from spring to fall
Rosemary	Rosmarinus officinalis	2 x 2'	full	well drained	Evergreen	

RECOMMENDED PLANTS FOR:

EDGE



Carissa Holly



Rosemary



Boxwood

MASSING

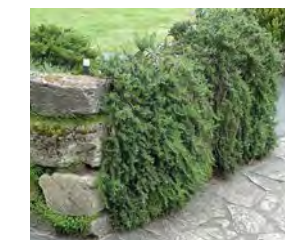

Creeping Rosemary



Indigo



Butterfly Iris



'New Gold' Lantana



'White Cloud' Muhly Grass



Gulf Muhly

SCREENING



Dwarf Yaupon

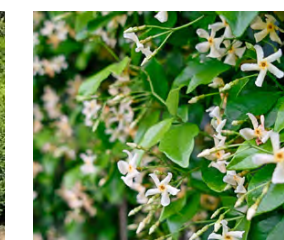

Florida Jasmine

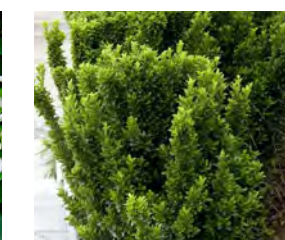

'Green Spire' Euonomous

NATURALIZED

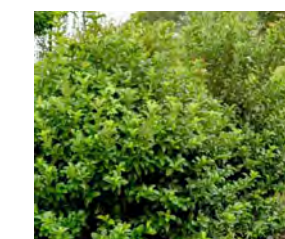

Sweet Viburnum

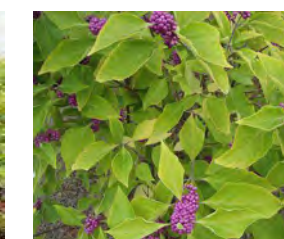

Mulberry

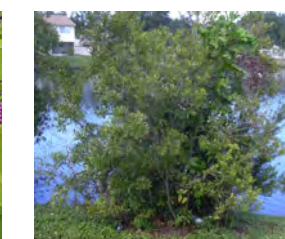

'Don'sDwarf' Wax Myrtle

Creeping Rosemary	Rosmarinus officinalis Prostratus	2 x 3'	full	acidic	Evergreen	Tolerates great heat and blazing sun as well as cold
Asiatic Jasmine	Trachelospermum asiatica	20' vine	full	well drained	Evergreen	Most use this groundcover where turfgrass won't grow, tolerate many growing conditions
Florida Jasmine	Trachelospermum jasminoides	vine	full	well drained	Evergreen	Showy Yellow Jasmine makes a great low evergreen groundcover or hedge
Purple Queen	Tradescantia pallida	2 x 2'	full	well drained	Everpurple	Better to confine it to a limited area and keep it in bounds
Sweet Viburnum	Viburnum odoratissimum	12 x 8'	partial shade	loose	Semi-evergreen	Lustrous Evergreen Foliage. Ideal for a wildlife garden.

* Additional plant material will be considered with prior LSU landscape architect approval.



Recent planting projects in the Memorial Oak Grove represent good use of groundcover massing and scale with larger accent shrubs interspersed. Note the use of groundcover to frame a figure of lawn.



3.8 LAWN

LAWN

DESIGN RATIONALE

Serving as a unifying feature, lawn is an essential component of the campus open space fabric. It provides both an inherent durability and flexibility in order to support many user groups and a range of activity - from tailgating to frisbee to study groups. Lawns are also the most maintenance-intensive plantings on campus, requiring mowing and watering year round, with more frequent intensity during the warmer months of the year.

The Campus Standard Sod for Athletic Fields and Facilities is ‘Celebration’ Bermuda. ‘Celebration’ has proven to be an excellent variety of Bermuda with exceedingly vigorous growth and recoverability for locations that receive enough sunlight. In addition to Athletic venues, ‘Celebration’ Bermuda can be found on the LSU Parade Ground.

The Campus Standard Sod for the Academic Campus is Geo Zoysia. ‘Geo’ Zoysia has been adopted for the main campus due to its wear toughness and ability to grow well in the shade.

Acceptable Alternatives to ‘Geo’ Zoysia include ‘Emerald’ Zoysia & ‘Empire’ Zoysia.

SPECIFICATIONS

All sod shall be certified, installed 24 hours within cutting, laid solid without gaps on a properly graded site and thoroughly watered in after planting.

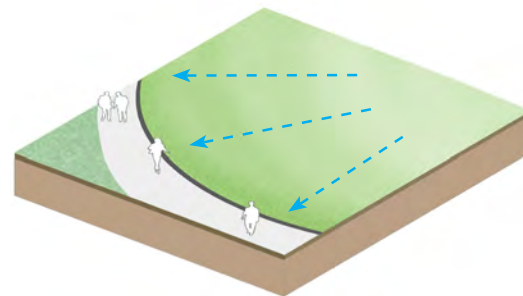
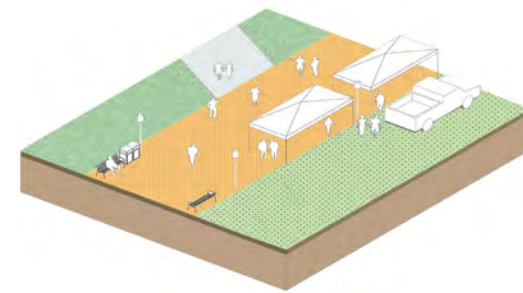
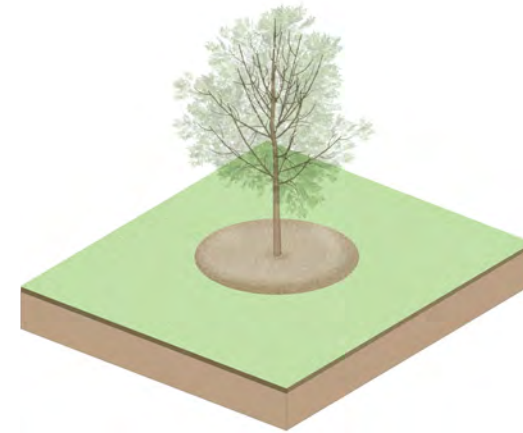

HOW TO DESIGN & MANAGE:

AROUND TREES

Provide mulch rings around new trees to ensure they maintain adequate moisture and to protect their roots from overcompaction. Adjust the size of mulch rings as the trees grow.

REINFORCED LAWN

Fiber reinforcement in high-use lawns prevents the soil from overcompacting and from rutting when wet. Install fibers during construction or resodding projects per the manufacturer’s recommendations

HIGH POINTS & LOW POINTS

Grade lawns to avoid creating low points in the lawn areas. Locate catch basins near edges of lawns to capture both sidewalk and lawn runoff.



Mulch rings support tree health and provide a clean maintenance transition



Reinforcement protects lawns against damage from vehicles or excessive foot traffic



Grading lawns to a positive form creates better spaces

COMMON NAME	SCIENTIFIC NAME	TOLERANCES				USES / COMMENT
		HEAT	TRAFFIC	SHADE	DROUGHT	
‘Celebration’ Bermuda	Celebration Bermuda	excellent	excellent	poor	excellent	dark blue-green; medium texture; requires less mowing than typical Bermuda varieties
‘Geo’ Zoysia	Geo Zoysia	excellent	very good	excellent	excellent	dark green; fine texture; good to excellent shade tolerance, and is extremely wear tolerant
‘Emerald’ Zoysia	Emerald Zoysia	excellent	very good	very good	very good	dark green; fine texture; low growth habit which requires less mowing
‘Empire’ Zoysia	Empire Zoysia	excellent	very good	very good	very good	medium blade width; requires less maintenance and mowing than other grasses such as Fescue or Bermuda.



3.9 PLANTING DETAILS

PLANTING DETAILS

NOTES:
 SOIL MIXTURE TO CONSIST OF 1#3 ORGANIC SOIL, 1#3 SAND FILL,
 AND 1#3 EXISTING SOIL.
 CONTRACTOR SHALL MIX IN SLOW RELEASE GRANULAR FERTILIZER
 AND PRE-EMERGENT ONCE SOIL IS READY FOR PLANTING.



TYP. PLANTING SOIL PROFILE
 DETAIL N.T.S.

GROUNDCOVER PLANTING
 DETAIL N.T.S.

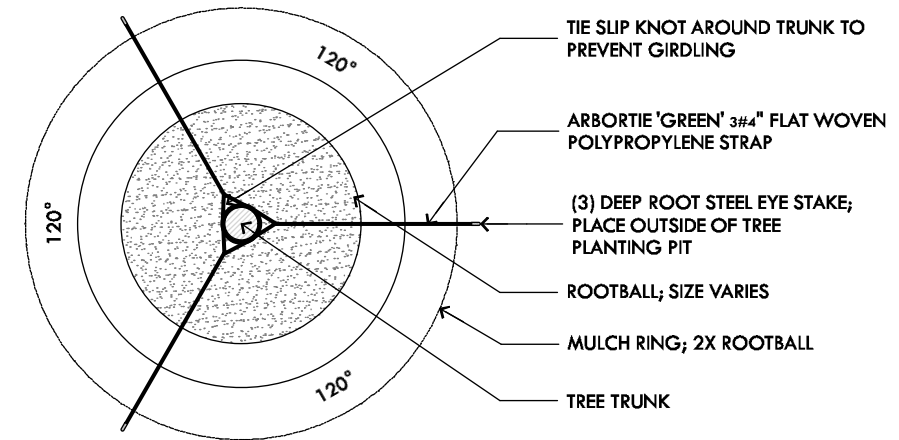

NOTES:
 1. FOR CONTAINER GROWN SHRUBS, USE FINGERS OR SMALL
 HAND TOOLS TO PULL THE ROOTS OUT OF THE OUTER LAYER OF
 POTTING SOIL, THEN CUT OR PULL APART ANY ROOTS THAT CIRCLE
 THE PERIMETER OF THE CONTAINER. 12" TO 18" FOR LARGER
 SHRUB ROOTBALLS, MAKE WIDTH MIN. 6" DEEPER THAN BALL.

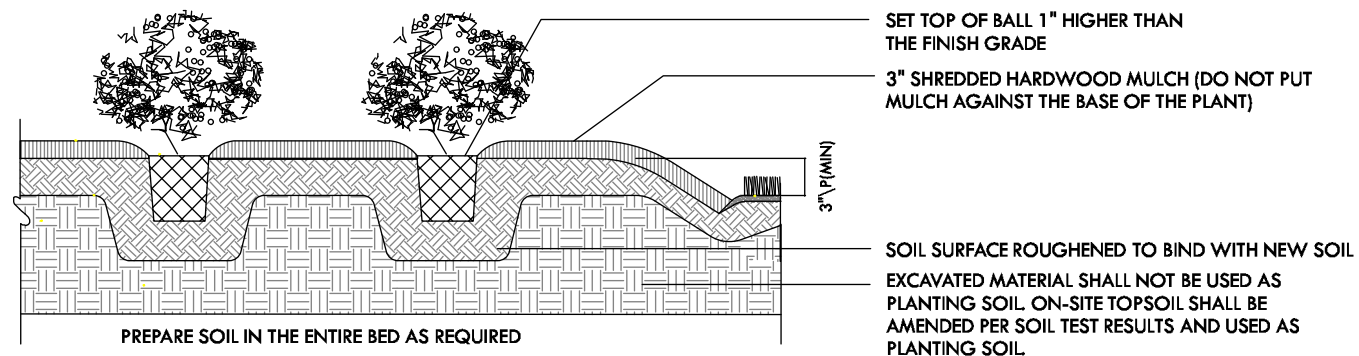

SHRUB PLANTING
 DETAIL N.T.S.

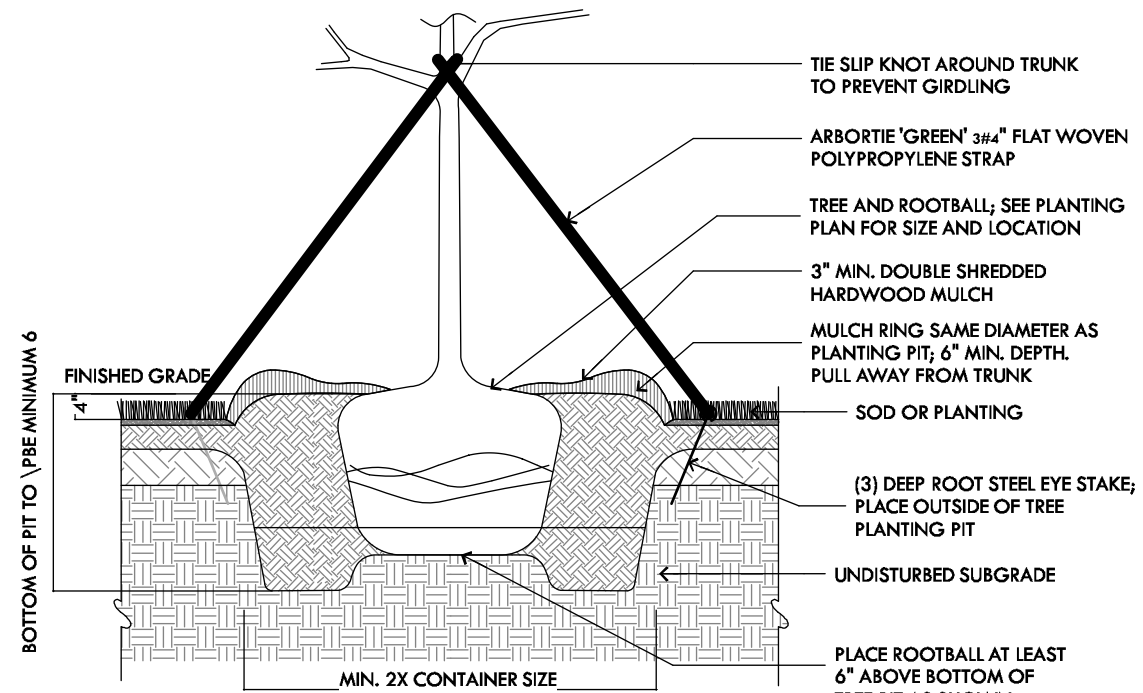

TREE PLANTING (SINGLE TRUNK)
 DETAIL N.T.S.